

CONTENTS

CONTROL AND OPERATION	3	SCHEMATIC DIAGRAM	15
DISASSEMBLY FOR REPAIR	5	EXPLODED VIEW	19
CIRCUIT DESCRIPTION	6	PARTS LIST	20
ADJUSTMENT/REGLAGES/ABGLEICH	9	SPECIFICATIONS (KA-691)	27
WIRING DIAGRAM	10	SPECIFICATIONS (KA-791)	Back cover
PC BOARD	11		

<KA-791 >

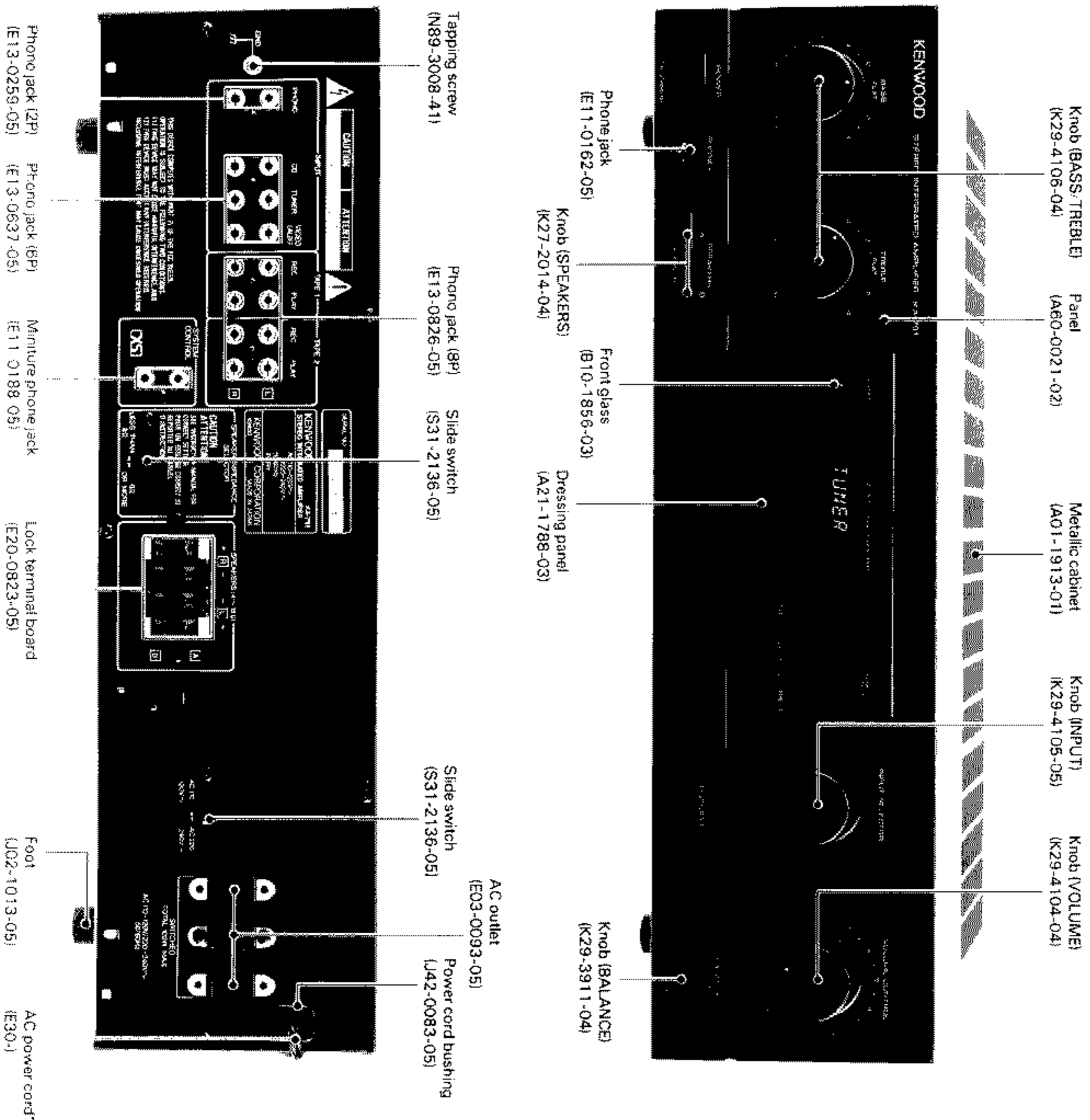
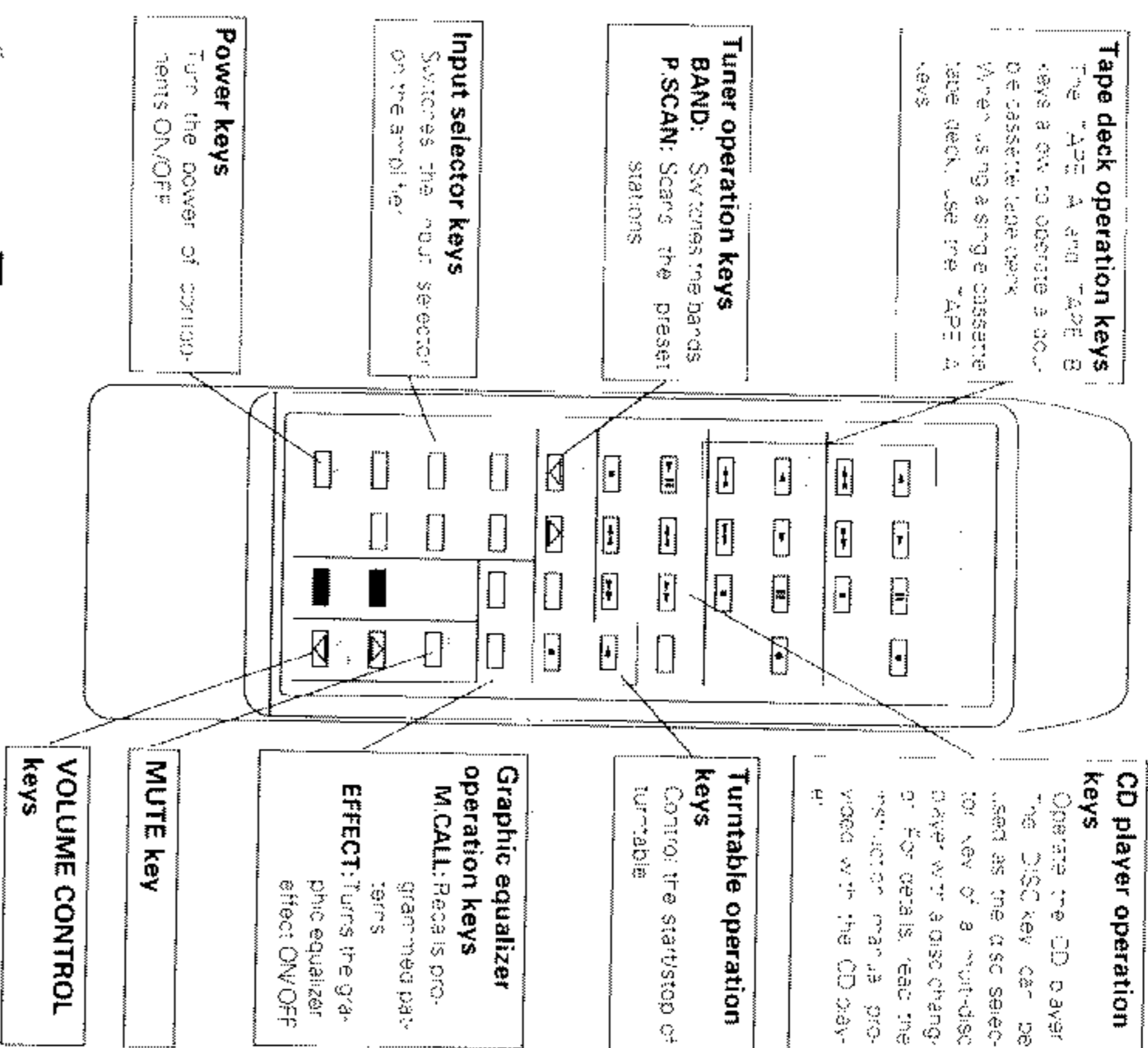

Photo is KA-791M
Refer to parts list on page 20.

CONTROL AND OPERATION

<KA-691 >



<KA-691 >

Accessories

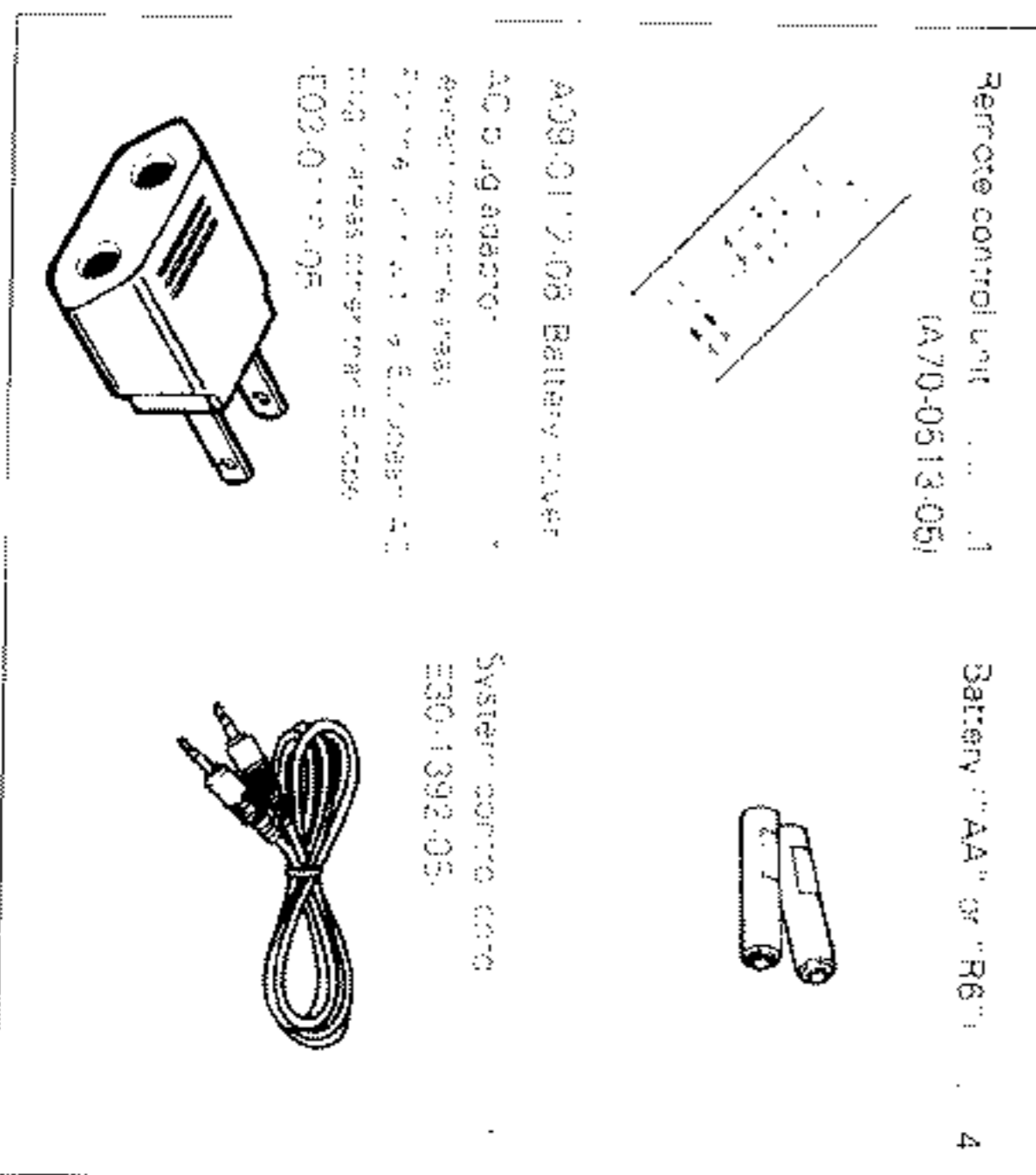

<KA-791 >

Accessories

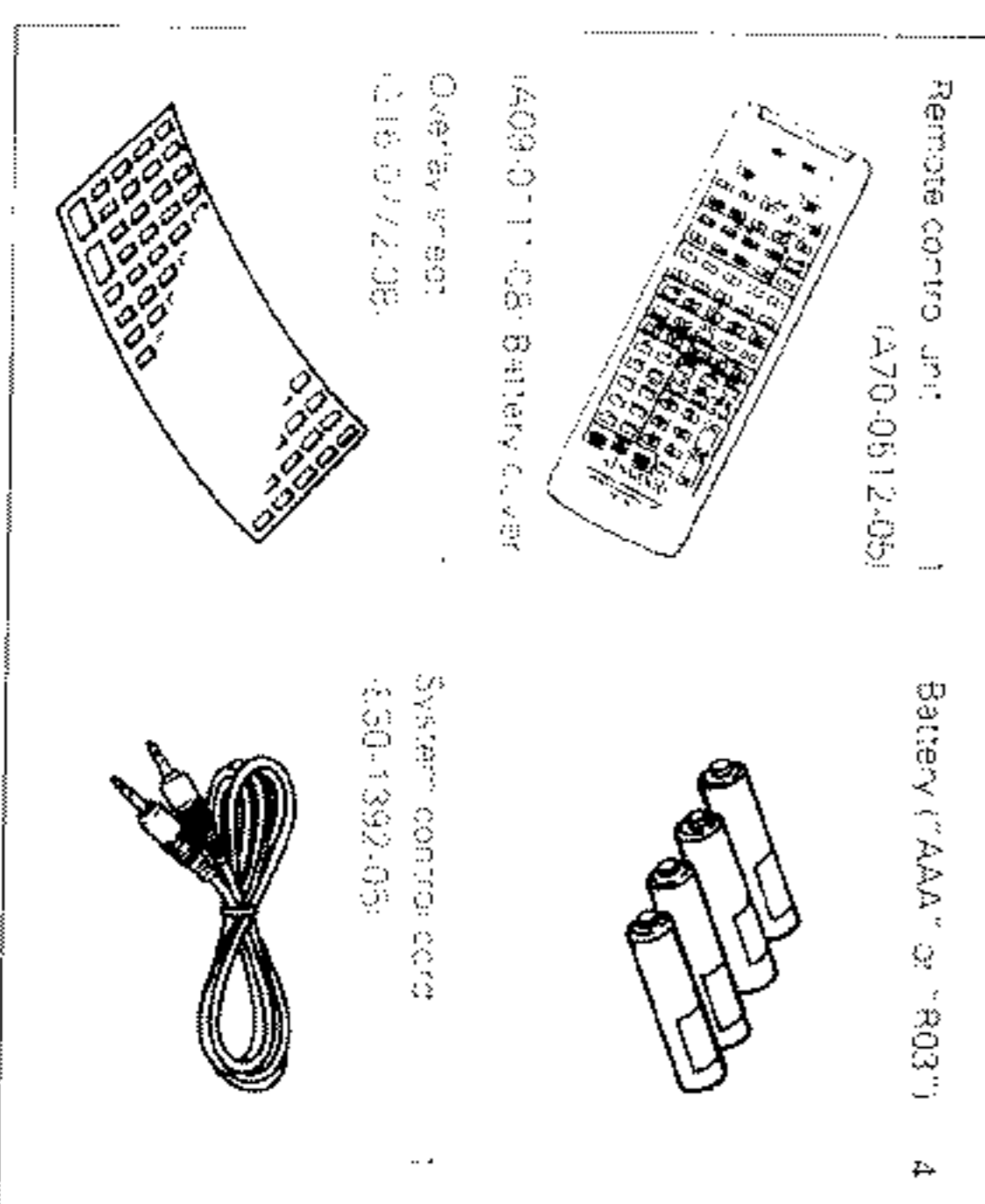

< KA-791 >

Keys marked with [] are functions which are not supported with this product.

LEARN indicator
Blinks or lights steadily during programming procedure.

LEARN/USE switch
Normally set to the USE position. Set to the LEARN position when programming remote control signals.

Tape deck/video deck operation keys
The TAPE A and TAPE B keys allow to operate a double cassette tape deck. When using a single cassette tape deck, use the TAPE A keys. A video deck can also be operated by programming the control signals of a video deck in the AUX mode.

Numeric keys
When the CD source is selected, these keys can be used as the numeric keys of the CD player. When the TUNER source is selected, they can be used as the numeric keys of the tuner.
How to enter numerals
For 23 press ± 0 twice and ± 3 .
For 40 press ± 10 four times and 0.

TUNER operation keys
BAND: Switches the bands.
P/SCAN: Scans the preset stations.
DIRECT: In conjunction with the numeric keys, turns stations directly. The DIRECT key cannot be used with the KT 591(S).

Input selector keys
Switches the input selector of the amplifier.

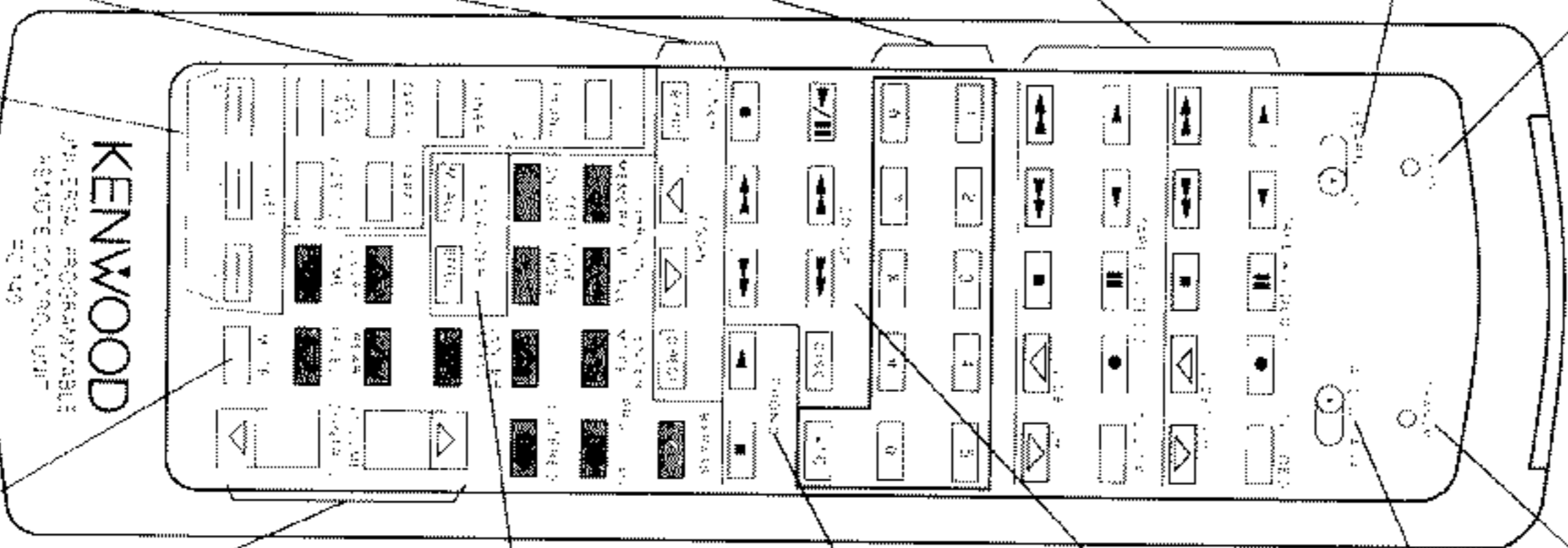

TRANSMIT indicator
Lights up while the remote control signal is being transmitted.

MODE switch
Selects the mode to be used.

CD player operation keys
Operate the CD player.
DISC: The DISC key can be used as the disc selector key of a multi-disc player with a disc changer. For details, read the instruction manual provided with the CD player.

Turntable operation keys
Control the start/stop of turntable.

Amplifier's equalizer operation keys
M/CALL: Recalls programmed patterns.

EFFECT: Turns the graphic equalizer effect ON/OFF.

VOLUME CONTROL keys
Adjust the volume. During operation, the VOLUME CONTROL on the front turns and the indicator on the knob blinks at high speed.

MUTE key
Press to reduce the volume temporarily. During operation, the indicator on the VOLUME CONTROL knob blinks.

POWER keys
Turn the power of components ON/OFF. For the TV and VIDEO keys, specific control signals should be programmed under them.

DISASSEMBLY FOR REPAIR

How to remove the repairing chassis

- 1 Cut the 6 parts ① of the repairing chassis. Remove the repairing chassis from main chassis.

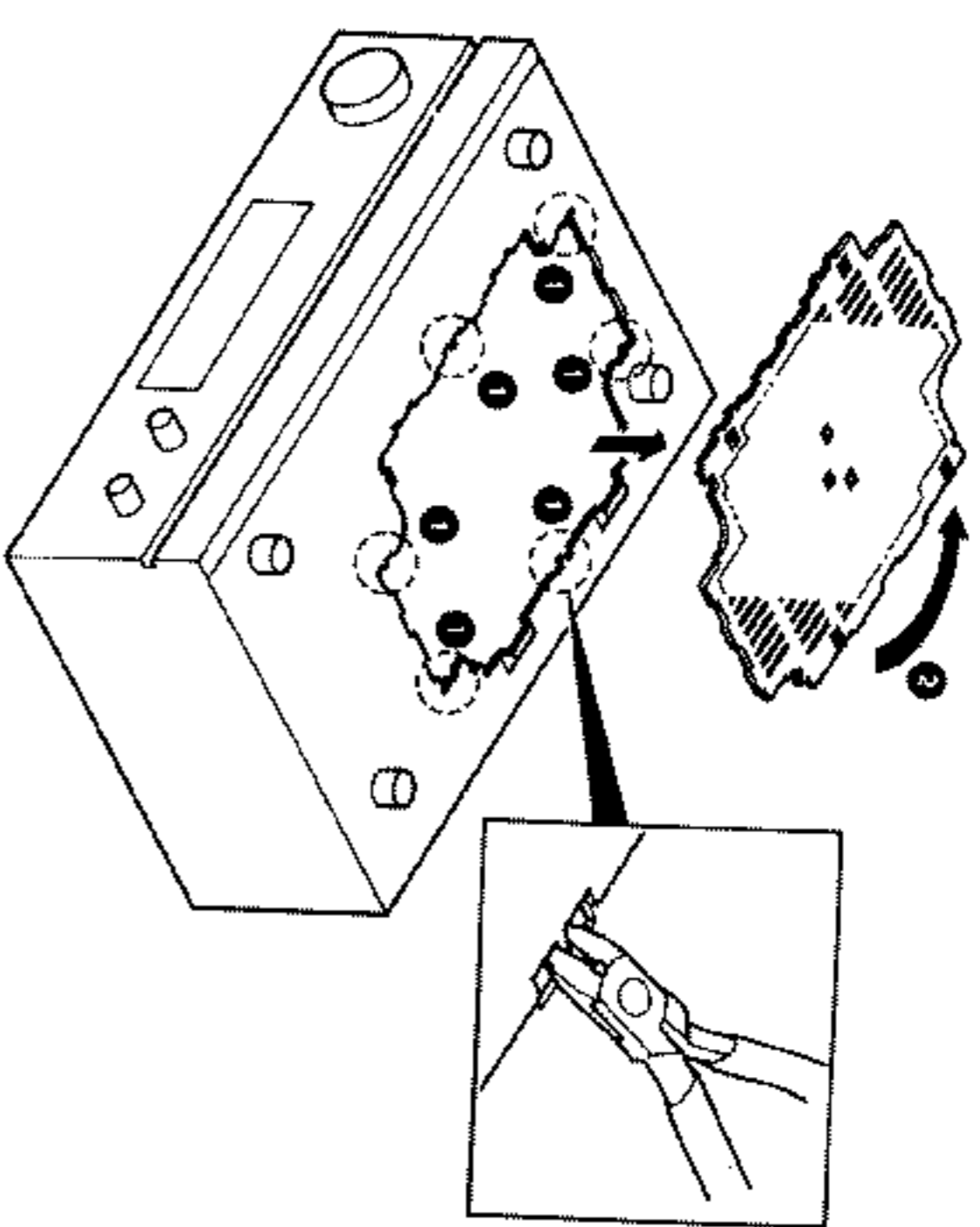

After repair

- 2 Turn the repairing chassis 180 degrees in the arrow direction ②.
- 3 Insert the 2 claws ③ into main chassis.
- 4 Lock to the main chassis by 2 screws (M3 X 6) ④.

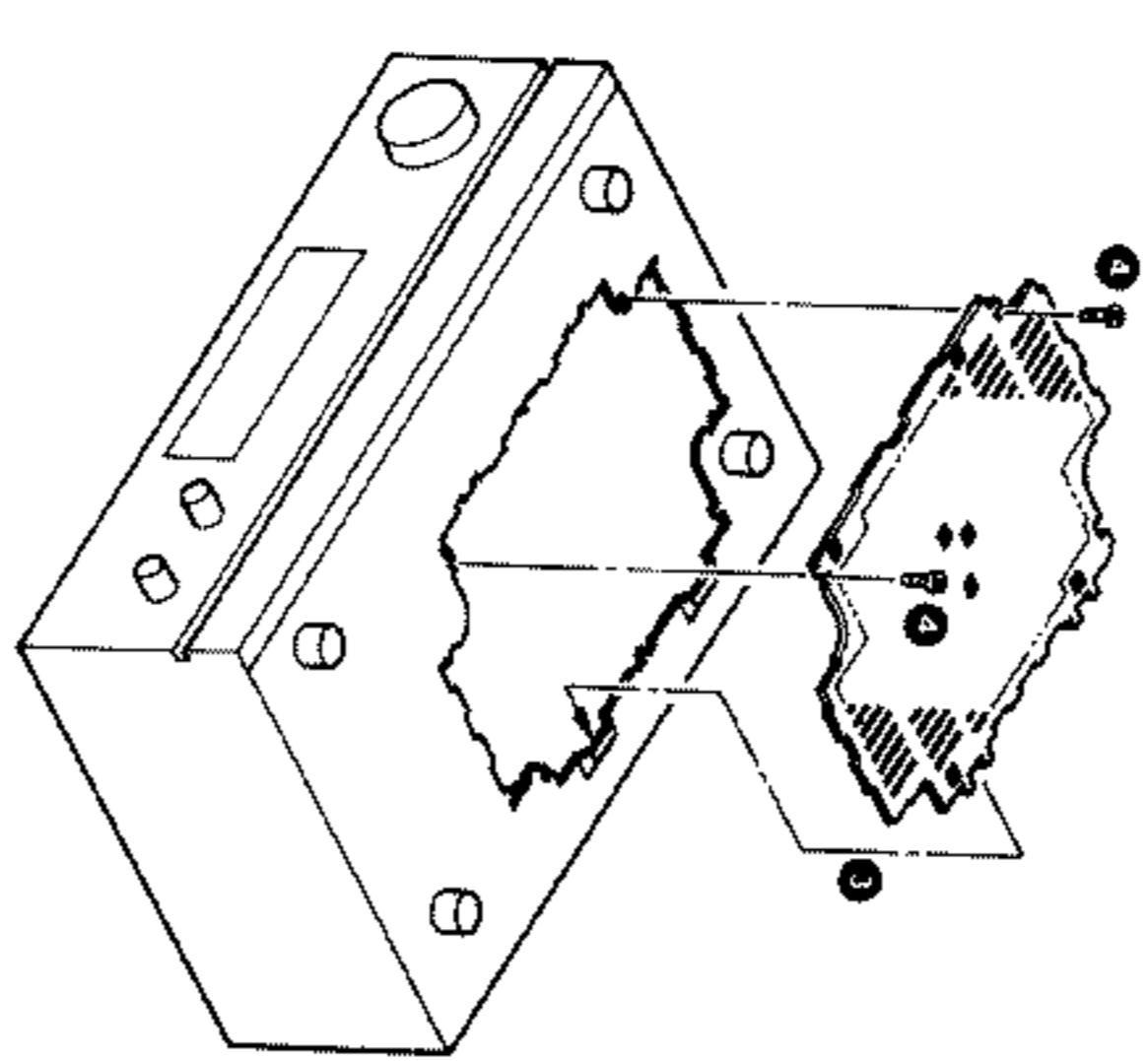

CIRCUIT DIAGRAM

CIRCUIT DIAGRAM

Micro processor (M50941-578SP)
Pin description

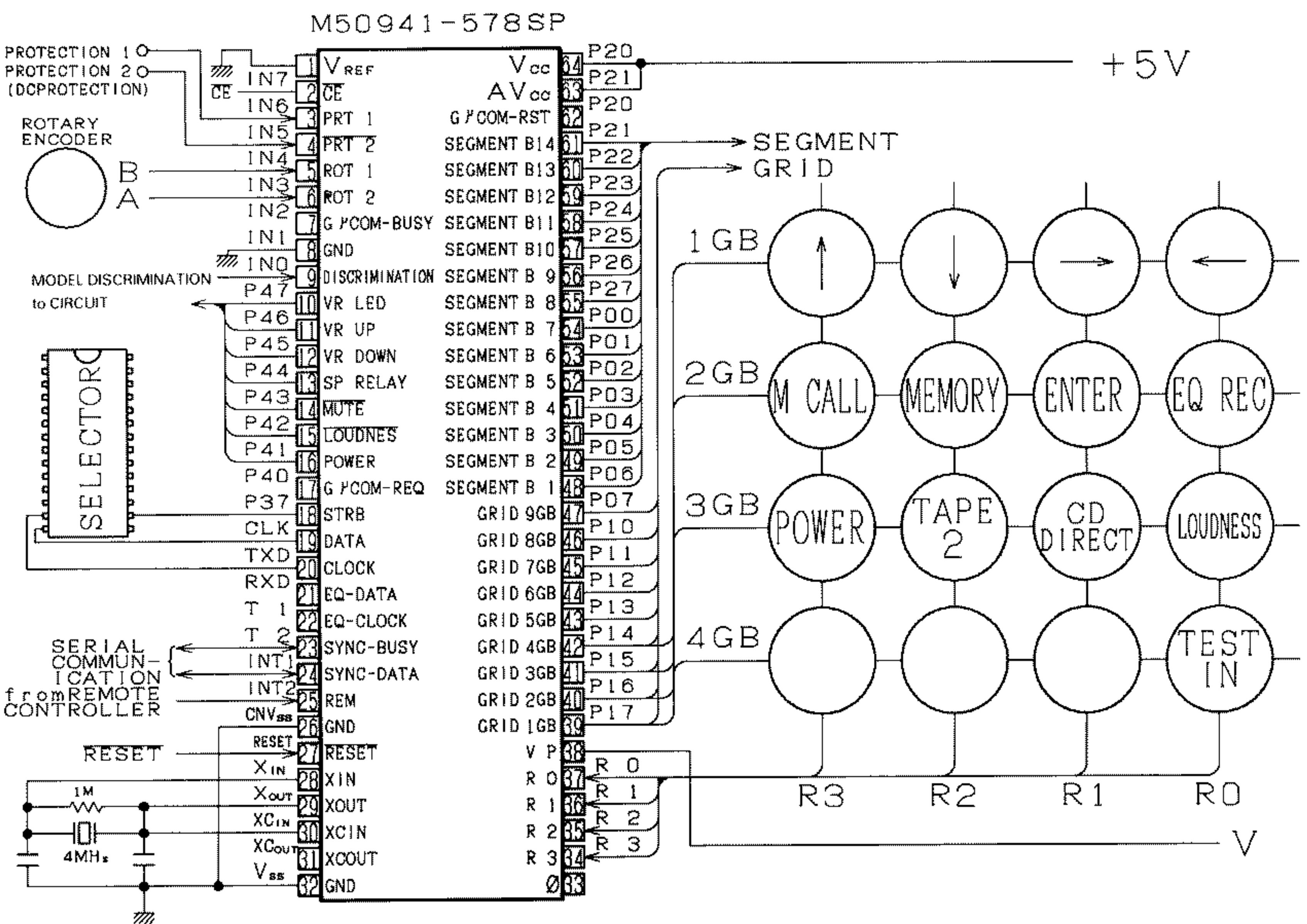

Pin description

Pin No.	Pin Name	I/O	Name	Description
1	VREF	I	OV	GND
2	IN 7	I	CE	Chip enable
3	IN 6	I	PRT 1	Protection
4	IN 5	I	PRT 2	DC protection
5	IN 4	I	ROT 1	Rotary encoder
6	IN 3	I	ROT 2	Rotary encoder
7	IN 2	I	G μCOM-BUSY	Display μ-COM busy
8	IN 1	I		
9	IN 0	I		
10	P4 7	O	VR LED	Volume LED
11	P4 6	O	VR UP	Volume up
12	P4 5	O	VR DOWN	Volume down
13	P4 4	O	SP RELAY	Speaker relay
14	P4 3	O	MUTE	Mute
15	P4 2	O	LOUDNESS	Loudness
16	P4 1	O	POWER	Power
17	P4 0	O	G μCOM-REQ	Display μ-COM request
18	P3 7 S-RDY	O	STRB	Strobe (Selector)
19	P3 6 CLK	O	DATA	Data (Selector, Display μ-COM)
20	P3 5 TXD	O	CLOCK	Clock (Selector Display μ-COM)
21	P3 4 RXD	O	EQ-DATA	Data for GE
22	P3 3 T1	O	EQ-CLOCK	Clock for GE
23	P3 2 T2	I/O	SYNC-BUSY	Syncro busy
24	P3 1 INT1	I/O	SYNC-DATA	Syncro data
25	P3 0 INT2	I	REM	Remote controller input
26	CNVSS	I	GND	
27	RESET	I	RESET	Reset
28	XIN	I	XIN	Clock
29	XOUT	O	XOUT	Clock
30	XCIN	I	XCIN	GND
31	XCOUT	O	XCOUT	
32	VSS	I	GND	
33	φ	O	φ	Timing output
34	R3	I	R3	Key return input 3
35	R2	I	R2	Key return input 2
36	R1	I	R1	Key return input 1
37	RO	I	RO	Key return input 0
38	VP	I	VP	Pull-down voltage
39	P1 7	O	GRID 1GB	Grid
40	P1 6	O	GRID 2GB	Grid
41	P1 5	O	GRID 3GB	Grid
42	P1 4	O	GRID 4GB	Grid
43	P1 3	O	GRID 5GB	Grid
44	P1 2	O	GRID 6GB	Grid

CIRCUIT DESCRIPTION

ADJUSTMENT/REGLAGE/ABGLEICH

Pin No.	Pin Name	I/O	Name	Description
45	P1 1	0	GRID 7G8	Grid
46	P1 0	0	GRID 8G8	Grid
47	PO 7	0	GRID 9G6	Grid
48	PO 6	0	SEGMENT B1	Segment
49	PO 5	0	SEGMENT B2	Segment
50	PO 4	0	SEGMENT B3	Segment
51	PO 3	0	SEGMENT B4	Segment
52	PO 2	0	SEGMENT B5	Segment
53	PO 1	0	SEGMENT B6	Segment
54	PO 0	0	SEGMENT B7	Segment
55	P2 7	0	SEGMENT B8	Segment
56	P2 6	0	SEGMENT B9	Segment
57	P2 5	0	SEGMENT B10	Segment
58	P2 4	0	SEGMENT B11	Segment
59	P2 3	0	SEGMENT B12	Segment
60	P2 2	0	SEGMENT B13	Segment
61	P2 1	0	SEGMENT B14	Segment
62	P2 0	0	G μCOM-RS1	Display μ-COM reset
63	P2 1	0	AVCC	Vcc
64	P2 0	0	Vcc	Vcc

TEST mode

1. Setting method

The power supply code is connected AC wall socket while pressing CD DIRECT key.

2. Content

- 2-1 A spectrum analyzer sections except for all FL tube is lighted.
- 2-2 When other key are pushed all illuminations are canceled.
- 2-3 EQ FREQ knob operation
A selection of a frequency is carried out similarly with at the time of an ordinarness.

2-4 EQ LEVEL knob operation

A level of frequency range where was selected is controlled with 3 point of MAX, CENTER, MIN.

2-5 M1: MAX segments of all frequency range turn ON
M2: MIN segments of all frequency range turn ON.
M3 — M5: Flat

2-6 CD DIRECT key operation Volume up
2-7 TAPE 2 key operation Volume down

INITIALIZATION

The power supply code is connected AC wall socket while pressing ENTER key.

ADJUSTMENT

No.	ITEM	INPUT SETTINGS	OUTPUT SETTINGS	AMPLIFIER SETTING	ALIGNMENT POINTS	ALIGN FOR	FIG.
Unless otherwise specified, set the respective switches as follows: POWER: ON SPEAKER: B REC OUT: OFF SELECTOR: PHONO							
1	IDLE CURRENT		Connect a DC voltmeter across CP1 (L) CP2 (R) (X09-)	VOLUME: 0	VR1 (L) VR2 (R) (X09-)	18mV	(a)

REGLAGES

N°	ITEM	REGLAGE DE L'ENTREE	REGLAGE DE LA SORTIE	REGLAGE DE L'AMPLIFICATEUR	POINTS DE L'ALIGNEMENT	ALIGNER POUR	FIG.
Sauf indication contraire, régler comme suit les commandes respectives: POWER: ON SPEAKER: B REC OUT: OFF SELECTOR: PHONO							
1	COURANT DE POLARISATION		Connecter un voltmètre de CC sur CP1 (G) CP2 (D) (X09-)	VOLUME: 0	VR1 (G) VR2 (D) (X09-)	18mV	(a)

ABGLEICH

NR.	GENGENSTAND	EINGANGS-EINSTELLUNG	AUSGANGS-EINSTELLUNG	VORSTÄRKEREINSTELLUNG	ABGLEICH-PUNKTE	ABGLEICHEN FÜR	ABB.
Wenn nicht anders angegeben, die einzelnen Schalter wie folgt einstellen: POWER: ON SPEAKER: B REC OUT: OFF SELECTOR: PHONO							
1	LEERLAUSTRIMM		Einen Gleichspannungsmesser über CP1 (L) CP2 (R) anschließen. (X09-)	VOLUME: 0	VR1 (L) VR2 (R) (X09-)	18mV	(a)

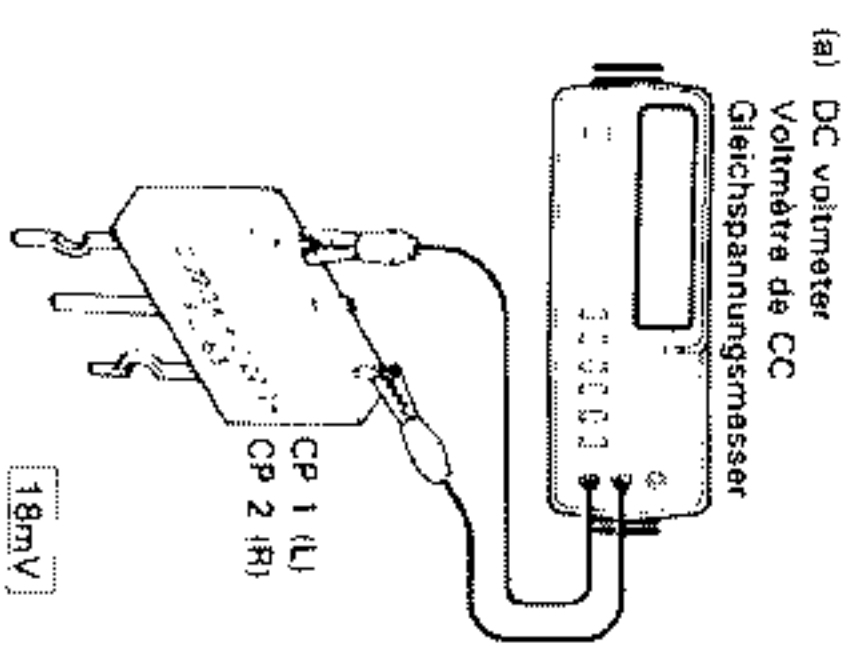

PC BOARD (Component Side View)

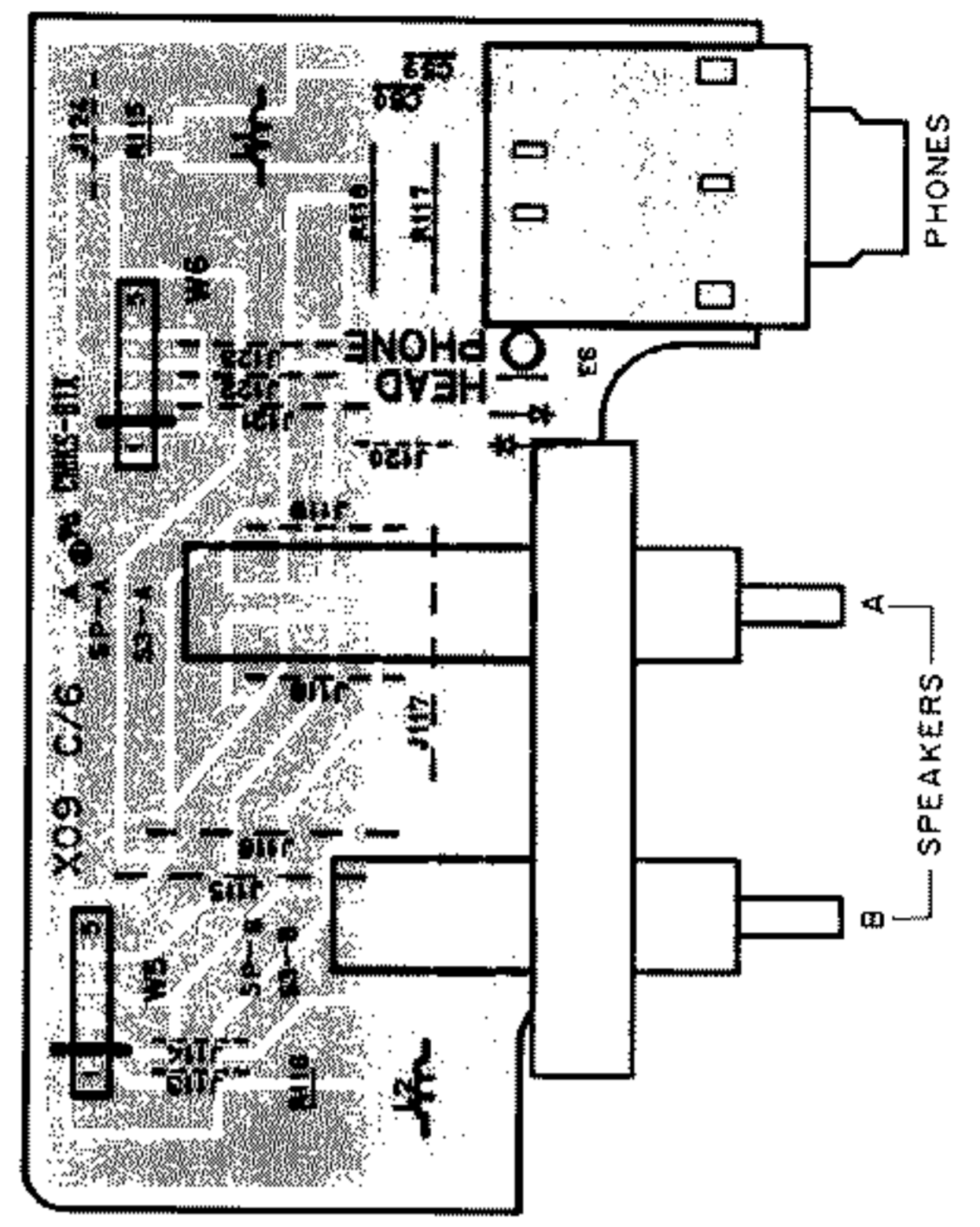
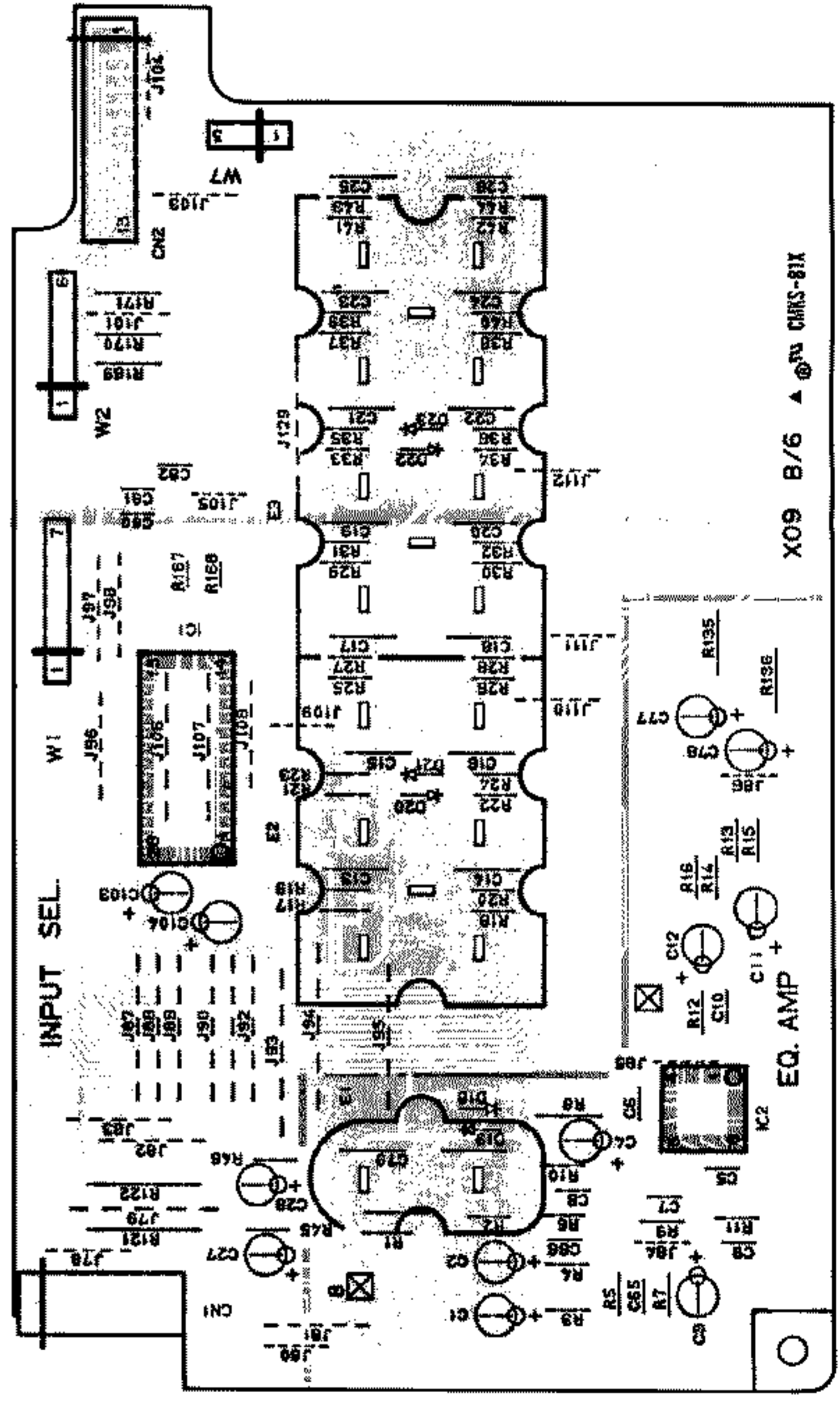
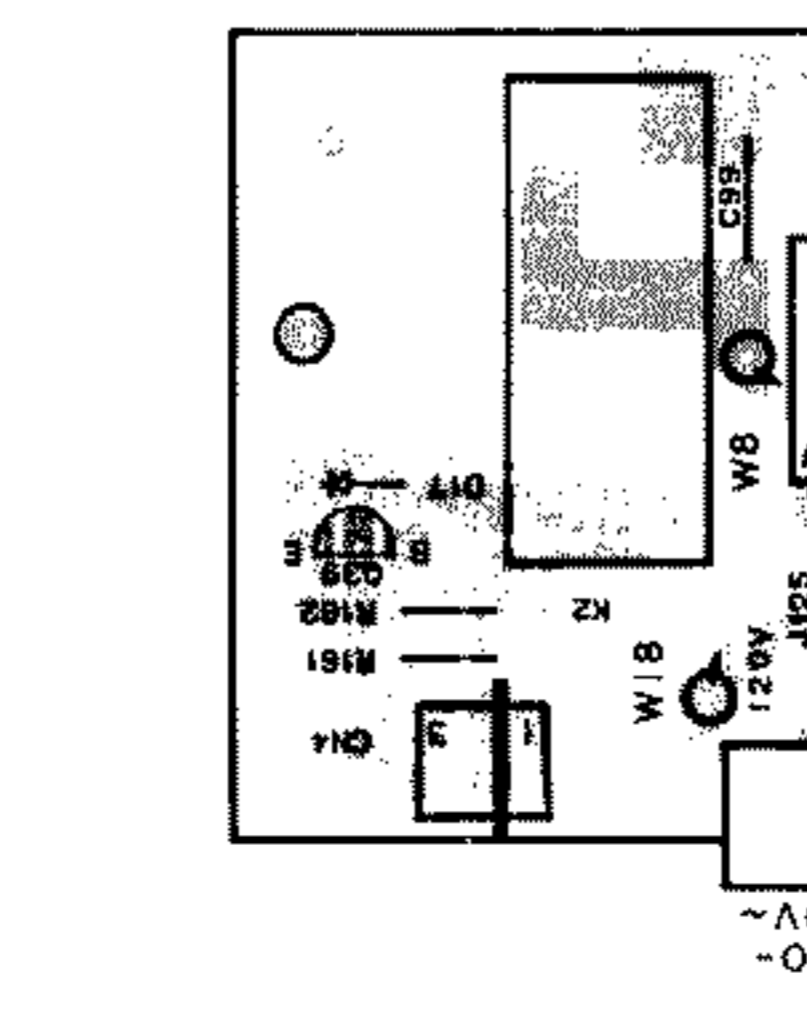
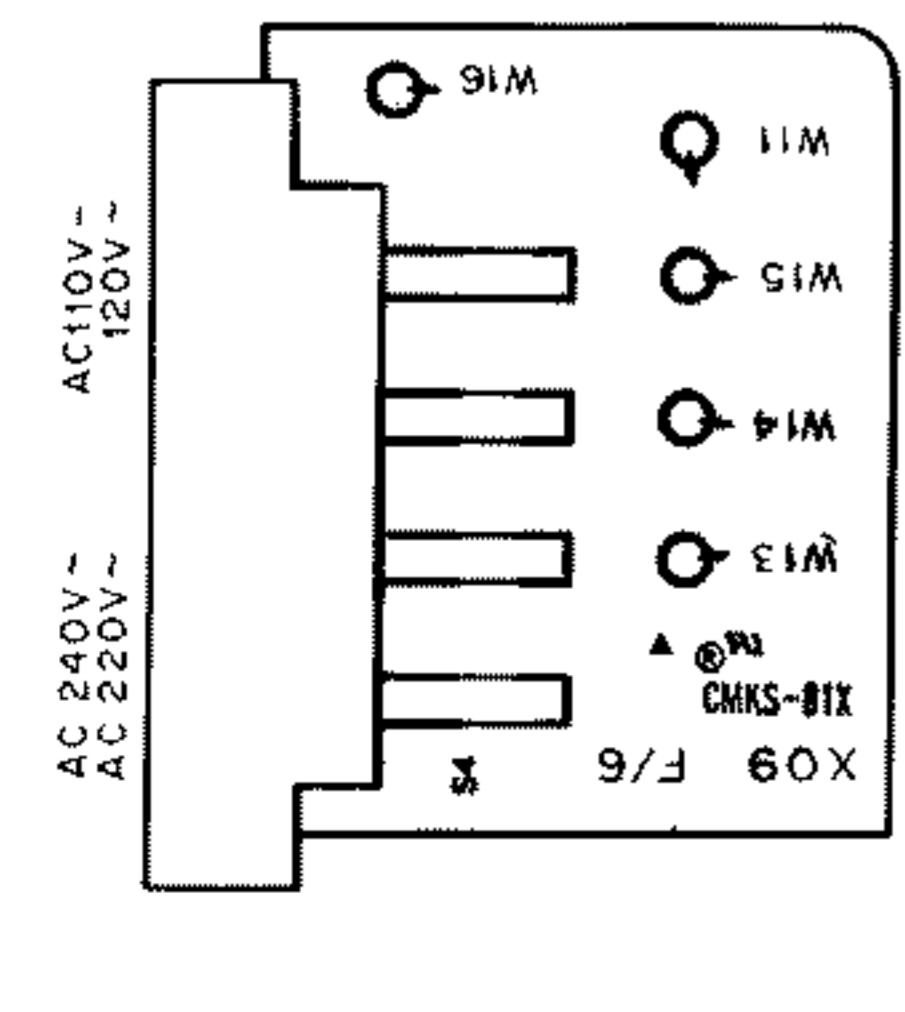
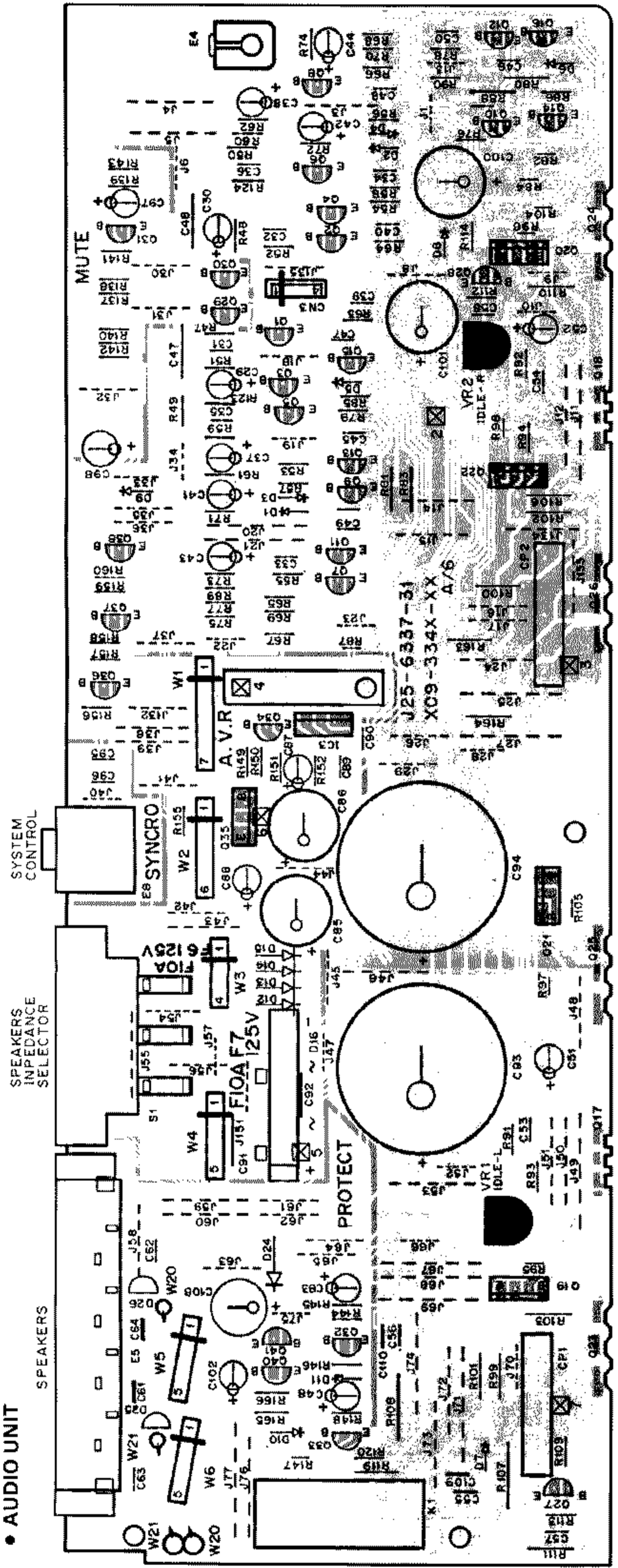

X11-303X-XX A-5
 C11
 C1
 C2

BA-0383
 2SC2465 C, R, P, 2SC2465Y, GR
 2SC2331 A, C, B
 2SC4935 C, B, Y, 2SC4935Y, GR
 2SC4935 C, B

D14-21 24-27
 28 36 39
 40 42
 43 44

330 1297 35
 586665 15R135 100
 755 11R2 10R25 ES B2
 752 11R2 10R25 ES B2

K09-334X-XX A-5

MODEL	DESTINATION	REP. NO.	DESIGNATION	WHY2
KA-691/791	JAPAN MADE	2 31	33P NC	YES 510
KA-691/791	JAPAN MADE	2 31	33P NC	YES 510
KA-691/791	JAPAN MADE	2 31	33P NC	YES 510
KA-691/791	JAPAN MADE	2 31	33P NC	YES 510
KA-691/791	JAPAN MADE	2 31	33P NC	YES 510
KA-691/791	JAPAN MADE	2 31	33P NC	YES 510
KA-691/791	JAPAN MADE	2 31	33P NC	YES 510
KA-691/791	JAPAN MADE	2 31	33P NC	YES 510
KA-691/791	JAPAN MADE	2 31	33P NC	YES 510
KA-691/791	JAPAN MADE	2 31	33P NC	YES 510

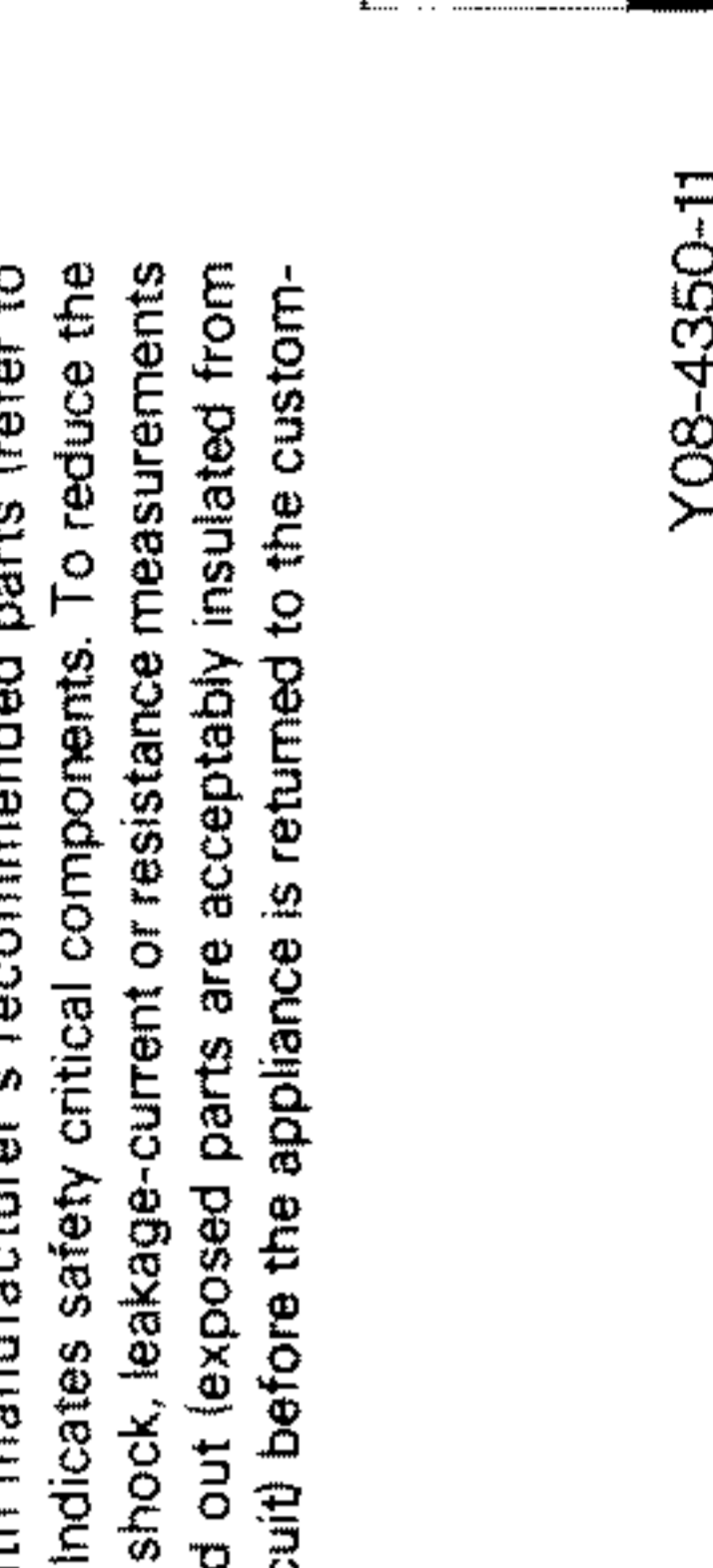
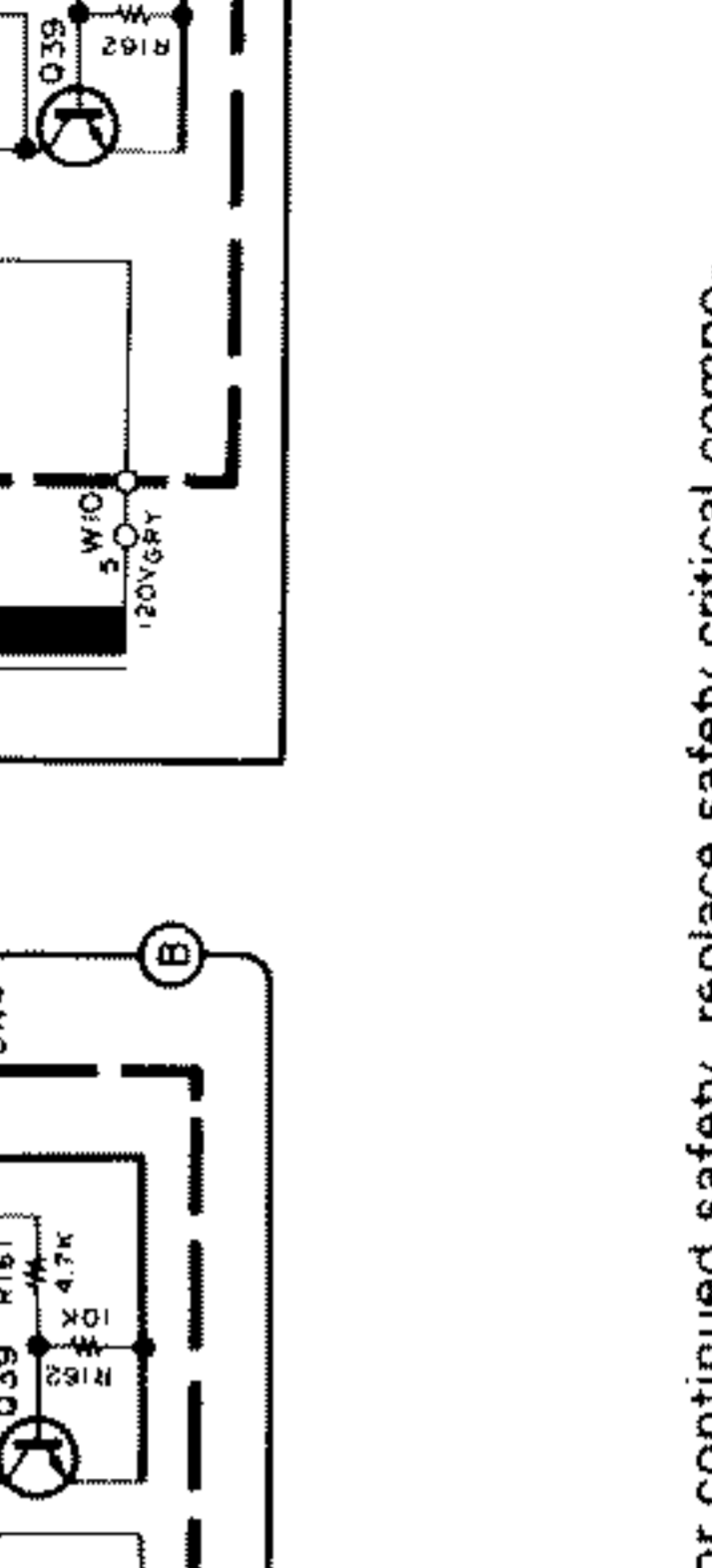
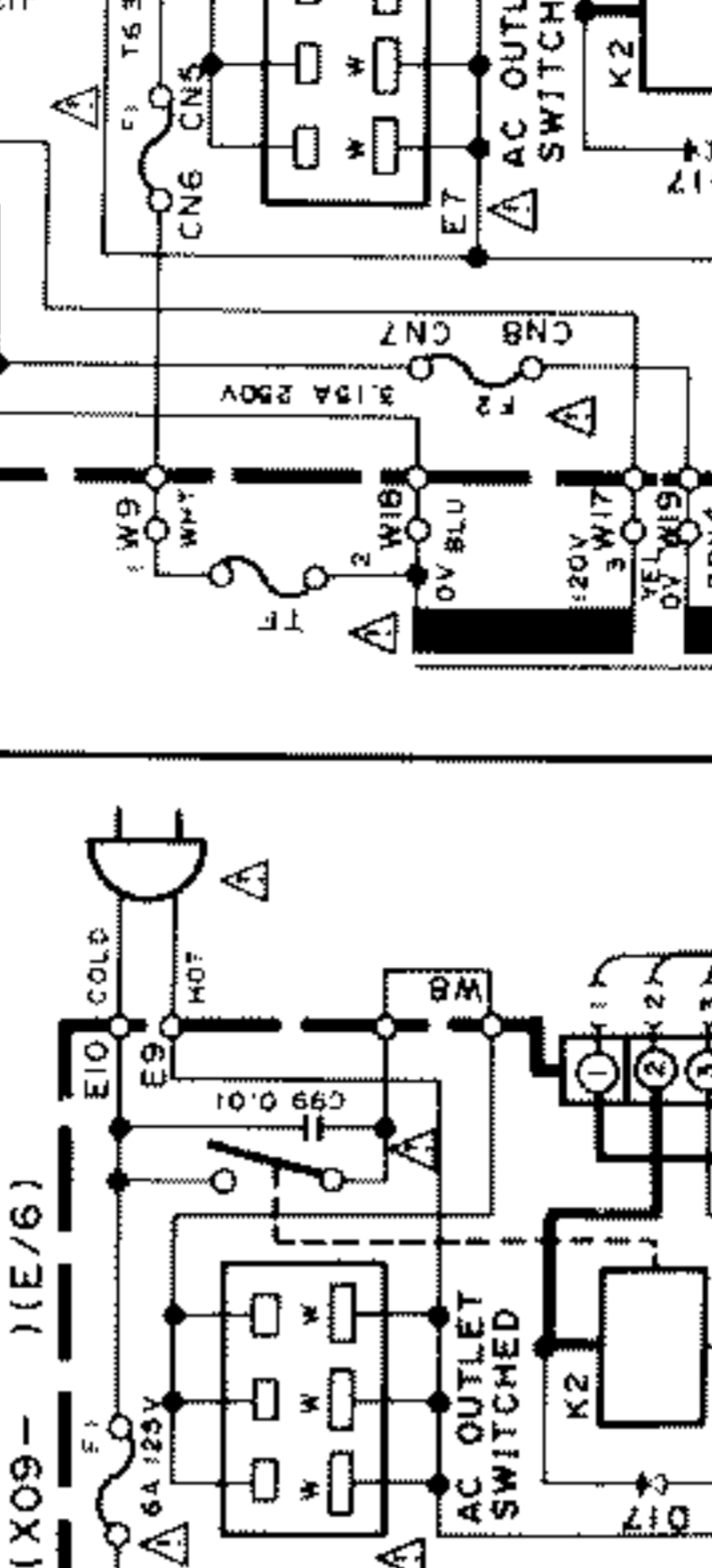
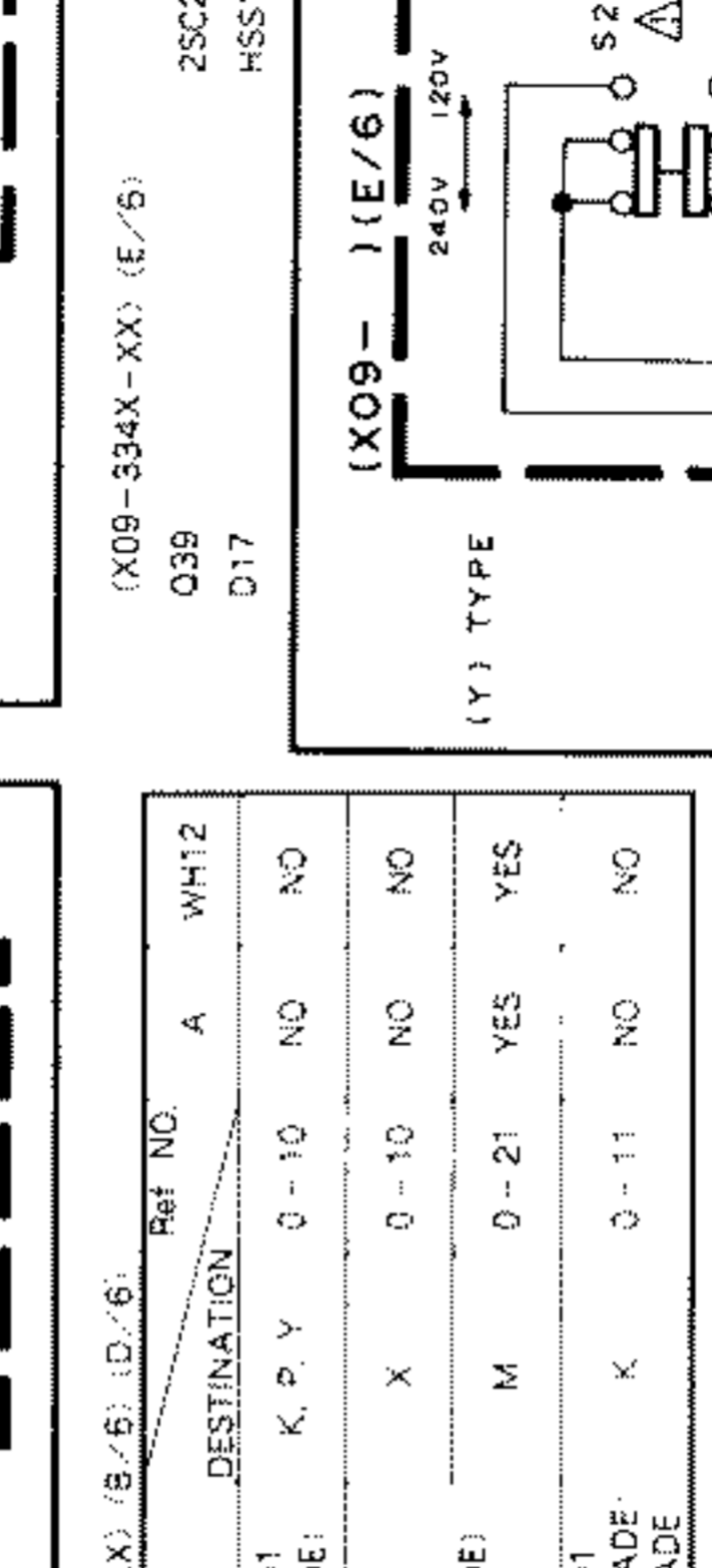
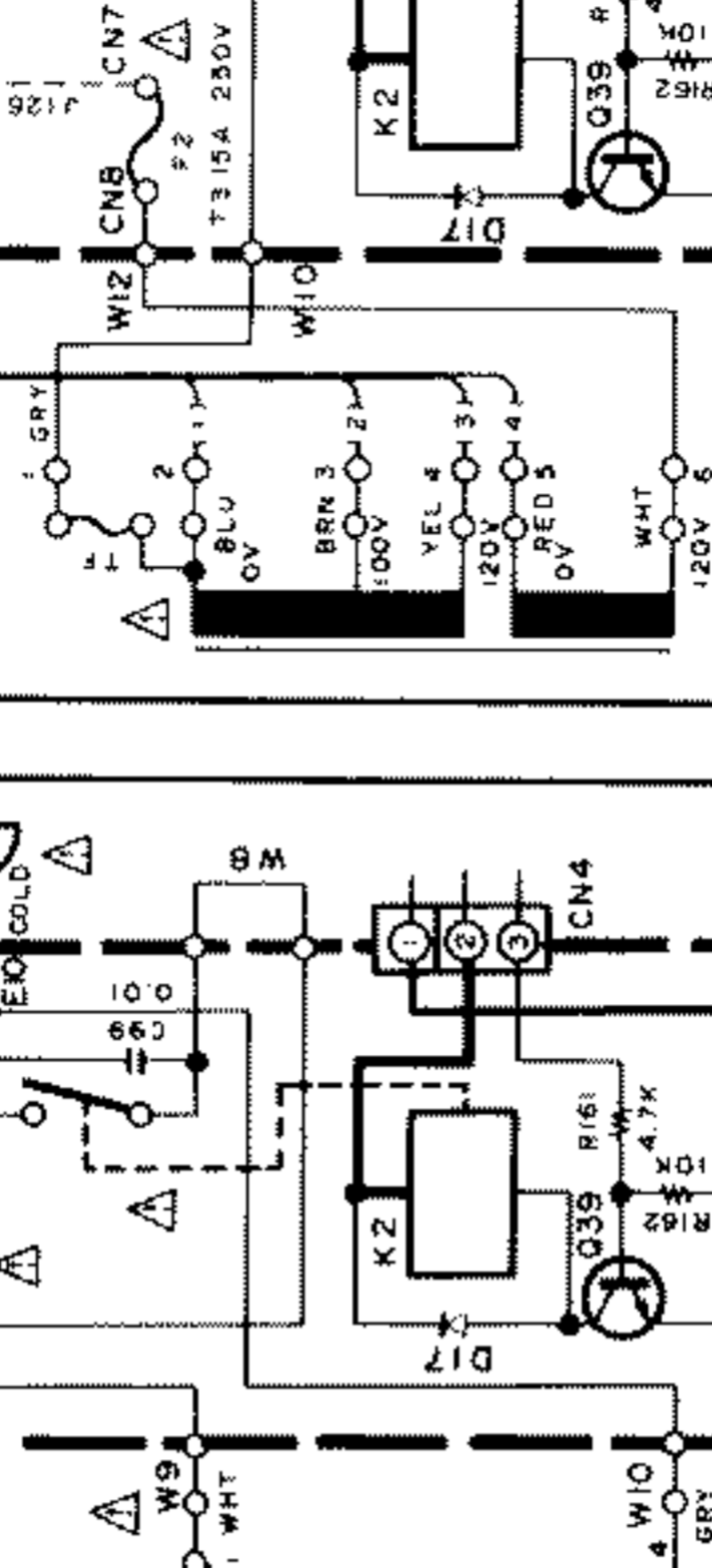
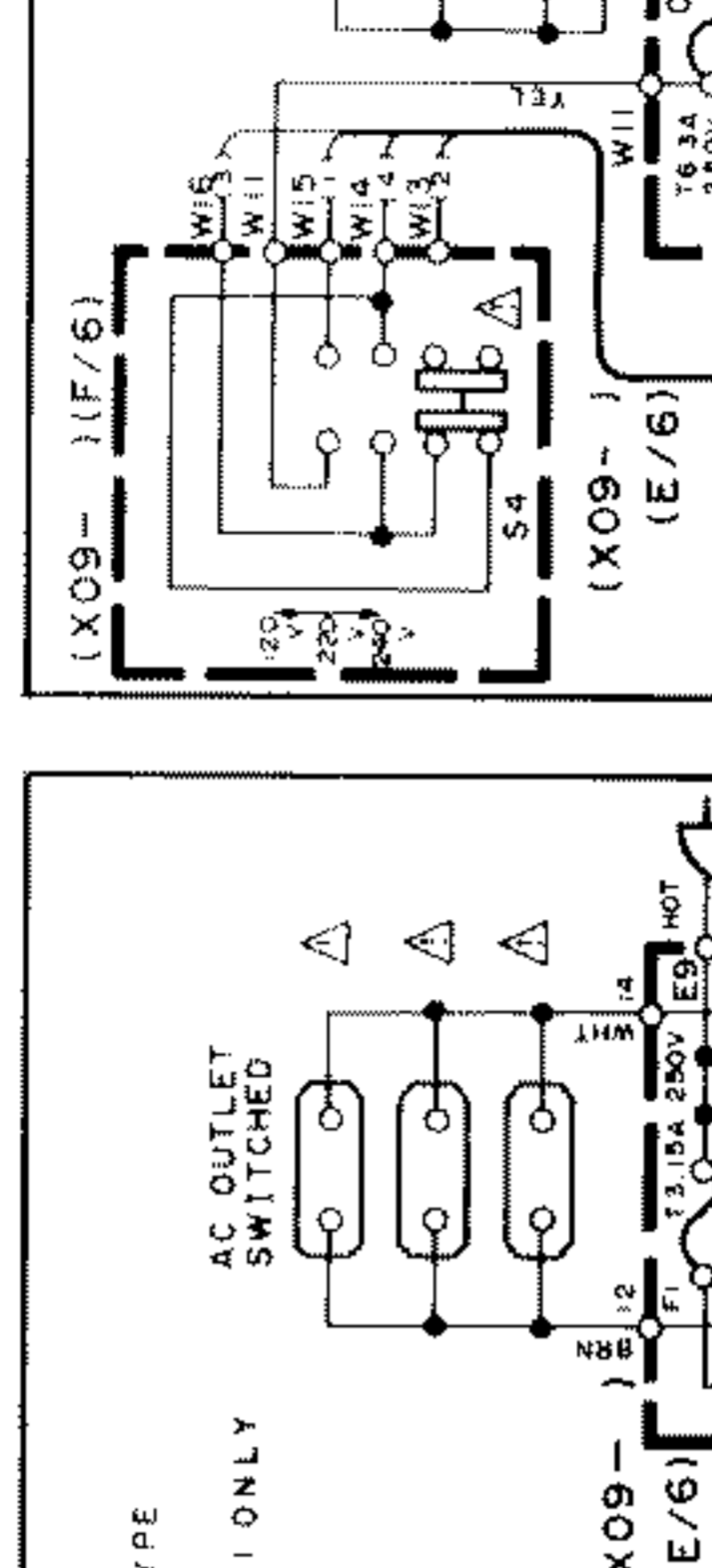
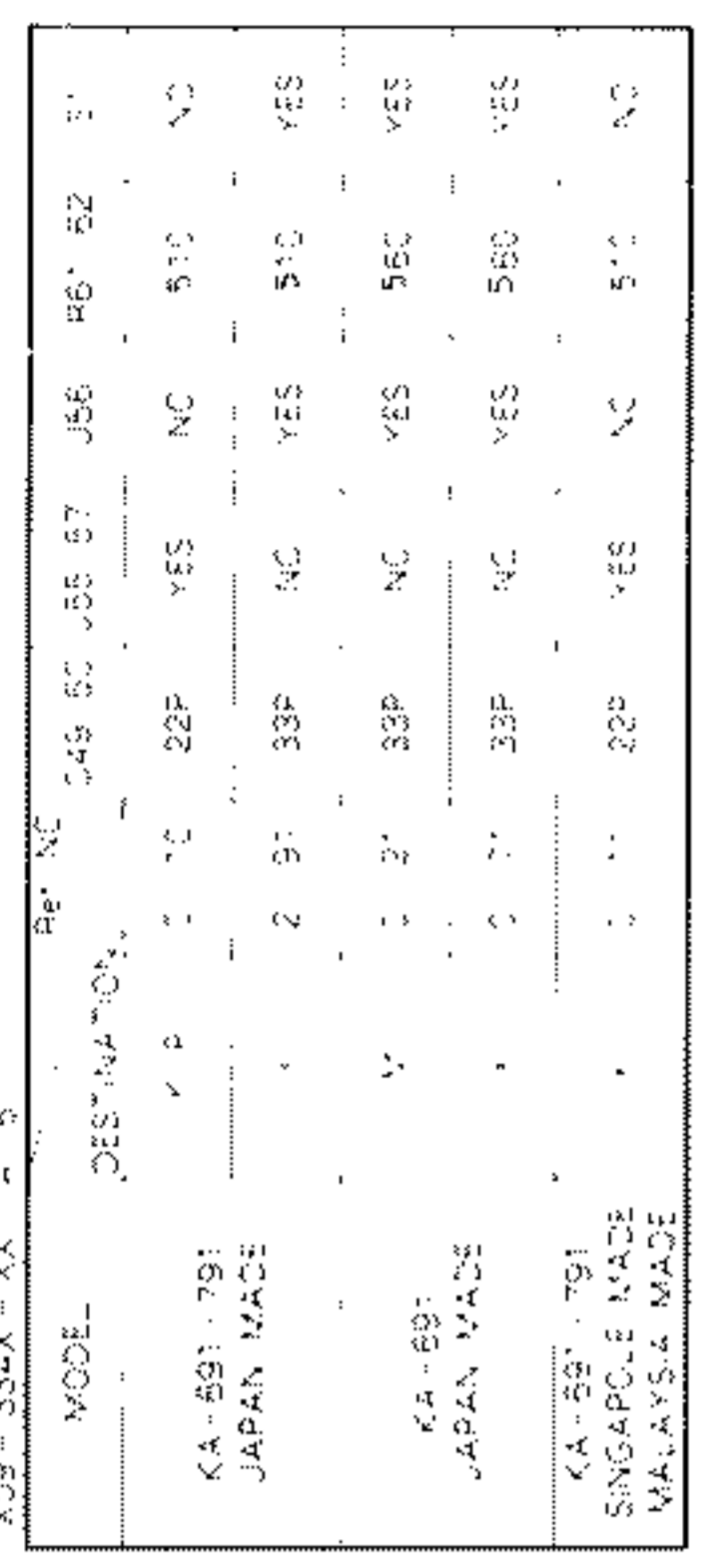
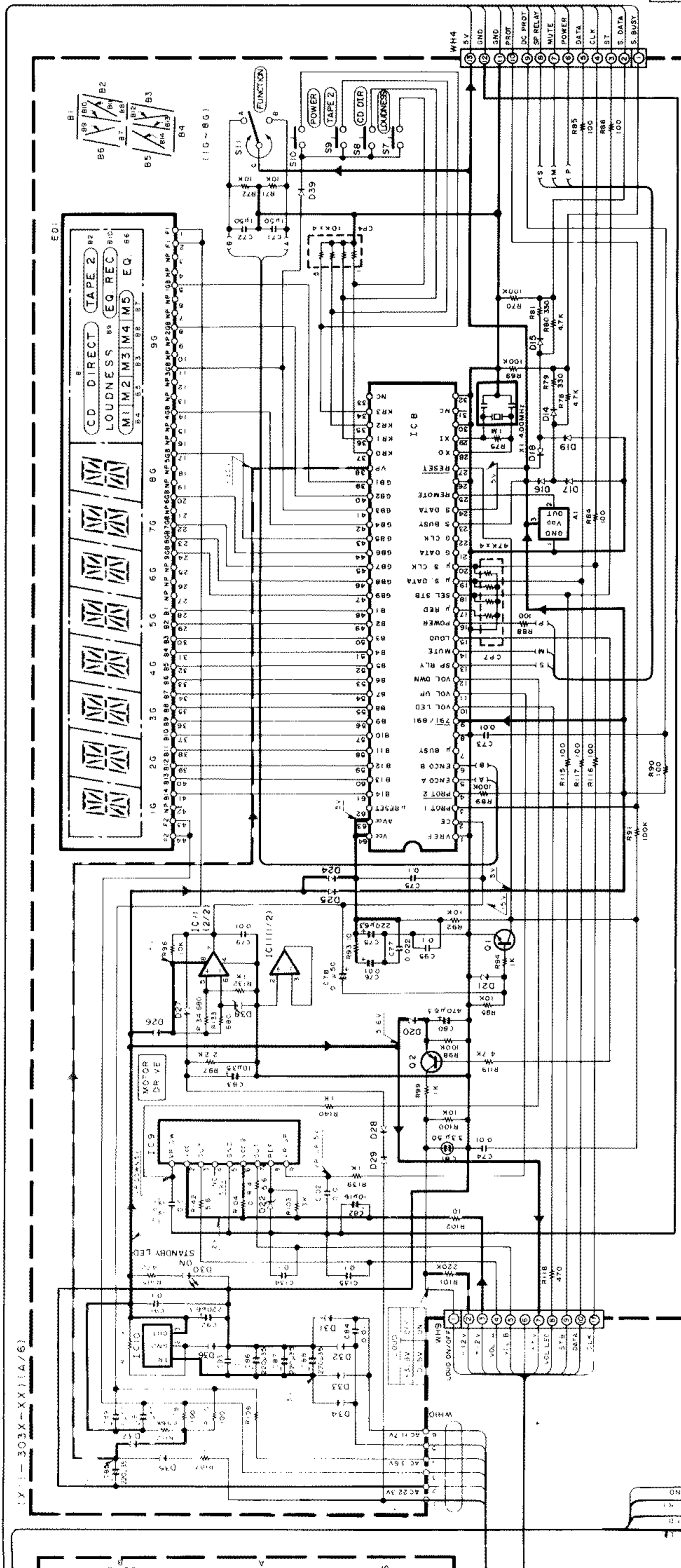

TC9162N
 TC9163N

M50941-589SP

TA7805S
 TA7812S

X11-303X-XX C-6
 C-3
 C-7 B

TC9162N
 TC9163N

X11-303X-XX B-6
 C-1
 C-3 4

J-PC4570C-4
 2SC1945 F E

X11-303X-XX (D-6)
 C-2

J-PC4570C-A

X11-303X-XX (E-6)
 C-2

J-PC4570C-A

X11-303X-XX (E-6)
 C-2

J-PC4570C-A

X11-303X-XX (E-6)
 C-2

J-PC4570C-A

IC1 (11/2)

IC2 (11/2)

IC3 (11/2)

IC4 (11/2)

IC5 (11/2)

IC6 (11/2)

IC7 (11/2)

IC8 (11/2)

IC9 (11/2)

IC10 (11/2)

IC11 (11/2)

IC12 (11/2)

IC13 (11/2)

IC14 (11/2)

IC1 (11/2)

IC2 (11/2)

IC3 (11/2)

IC4 (11/2)

IC5 (11/2)

IC6 (11/2)

IC7 (11/2)

IC8 (11/2)

IC9 (11/2)

IC10 (11/2)

IC11 (11/2)

IC12 (11/2)

IC13 (11/2)

IC14 (11/2)

IC1 (11/2)

IC2 (11/2)

IC3 (11/2)

IC4 (11/2)

IC5 (11/2)

IC6 (11/2)

IC7 (11/2)

IC8 (11/2)

IC9 (11/2)

IC10 (11/2)

IC11 (11/2)

IC12 (11/2)

IC13 (11/2)

IC14 (11/2)

IC1 (11/2)

IC2 (11/2)

IC3 (11/2)

IC4 (11/2)

IC5 (11/2)

IC6 (11/2)

IC7 (11/2)

IC8 (11/2)

IC9 (11/2)

IC10 (11/2)

IC11 (11/2)

IC12 (11/2)

IC13 (11/2)

IC14 (11/2)

IC1 (11/2)

IC2 (11/2)

IC3 (11/2)

IC4 (11/2)

IC5 (11/2)

IC6 (11/2)

IC7 (11/2)

IC8 (11/2)

IC9 (11/2)

IC10 (11/2)

IC11 (11/2)

IC12 (11/2)

IC13 (11/2)

IC14 (11/2)

IC1 (11/2)

IC2 (11/2)

IC3 (11/2)

IC4 (11/2)

IC5 (11/2)

IC6 (11/2)

IC7 (11/2)

IC8 (11/2)

IC9 (11/2)

IC10 (11/2)

IC11 (11/2)

IC12 (11/2)

IC13 (11/2)

IC14 (11/2)

8205HF
 7812HF

TA7805S
 TA7812S

M50941-589SP

TC9162N
 TC9163N

X11-303X-XX B-6
 C-1
 C-3 4

J-PC4570C-4
 2SC1945 F E

X11-303X-XX (D-6)
 C-2

J-PC4570C-A

X11-303X-XX (E-6)
 C-2

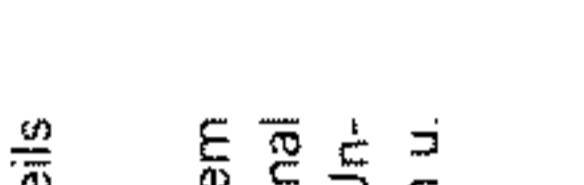
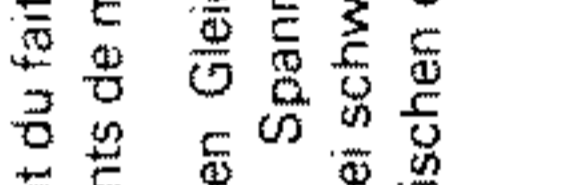

OUTPUT
 GND
 INPUT (Case)

OUTPUT
 GND
 INPUT (Case)

OUTPUT
 GND
 INPUT (Case)

OUTPUT
 GND
 INPUT (Case)

OUTPUT
 GND
 INPUT (Case)

OUTPUT
 GND
 INPUT (Case)

OUTPUT
 GND
 INPUT (Case)

8205HF
 7812HF

TA7805S
 TA7812S

M50941-589SP

TC9162N
 TC9163N

X11-303X-XX B-6
 C-1
 C-3 4

J-PC4570C-4
 2SC1945 F E

X11-303X-XX (D-6)
 C-2

J-PC4570C-A

X11-303X-XX (E-6)
 C-2

OUTPUT
 GND
 INPUT (Case)

OUTPUT
 GND
 INPUT (Case)

OUTPUT
 GND
 INPUT (Case)

OUTPUT
 GND
 INPUT (Case)

OUTPUT
 GND
 INPUT (Case)

OUTPUT
 GND
 INPUT (Case)

OUTPUT
 GND
 INPUT (Case)

8205HF
 7812HF

TA7805S
 TA7812S

M50941-589SP

TC9162N
 TC9163N

X11-303X-XX B-6
 C-1
 C-3 4

J-PC4570C-4
 2SC1945 F E

X11-303X-XX (D-6)
 C-2

J-PC4570C-A

X11-303X-XX (E-6)
 C-2

OUTPUT
 GND
 INPUT (Case)

OUTPUT
 GND
 INPUT (Case)

OUTPUT
 GND
 INPUT (Case)

OUTPUT
 GND
 INPUT (Case)

OUTPUT
 GND
 INPUT (Case)

OUTPUT
 GND
 INPUT (Case)

OUTPUT
 GND
 INPUT (Case)

8205HF
 7812HF

TA7805S
 TA7812S

M50941-589SP

TC9162N
 TC9163N

X11-303X-XX B-6
 C-1
 C-3 4

J-PC4570C-4
 2SC1945 F E

X11-303X-XX (D-6)
 C-2

J-PC4570C-A

X11-303X-XX (E-6)
 C-2

OUTPUT
 GND
 INPUT (Case)

OUTPUT
 GND
 INPUT (Case)

OUTPUT
 GND
 INPUT (Case)

OUTPUT
 GND
 INPUT (Case)

OUTPUT
 GND
 INPUT (Case)

OUTPUT
 GND
 INPUT (Case)

OUTPUT
 GND
 INPUT (Case)

8205HF
 7812HF

TA7805S
 TA7812S

M50941-589SP

TC9162N
 TC9163N

X11-303X-XX B-6
 C-1
 C-3 4

J-PC4570C-4
 2SC1945 F E

X11-303X-XX (D-6)
 C-2

J-PC4570C-A

X11-303X-XX (E-6)
 C-2

OUTPUT
 GND
 INPUT (Case)

OUTPUT
 GND
 INPUT (Case)

OUTPUT
 GND
 INPUT (Case)

OUTPUT
 GND
 INPUT (Case)

OUTPUT
 GND
 INPUT (Case)

OUTPUT
 GND
 INPUT (Case)

OUTPUT
 GND
 INPUT (Case)

8205HF
 7812HF

TA7805S
 TA7812S

M50941-589SP

TC9162N
 TC9163N

X11-303X-XX B-6
 C-1
 C-3 4

J-PC4570C-4
 2SC1945 F E

X11-303X-XX (D-6)
 C-2

J-PC4570C-A

X11-303X-XX (E-6)
 C-2

OUTPUT
 GND
 INPUT (Case)

OUTPUT
 GND
 INPUT (Case)

OUTPUT
 GND
 INPUT (Case)

OUTPUT
 GND
 INPUT (Case)

OUTPUT
 GND
 INPUT (Case)

OUTPUT
 GND
 INPUT (Case)

OUTPUT
 GND
 INPUT (Case)

8205HF
 7812HF

TA7805S
 TA7812S

M50941-589SP

TC9162N
 TC9163N

X11-303X-XX B-6
 C-1
 C-3 4

J-PC4570C-4
 2SC1945 F E

X11-303X-XX (D-6)
 C-2

J-PC4570C-A

X11-303X-XX (E-6)
 C-2

OUTPUT
 GND
 INPUT (Case)

OUTPUT
 GND
 INPUT (Case)

OUTPUT
 GND
 INPUT (Case)

OUTPUT
 GND
 INPUT (Case)

OUTPUT
 GND
 INPUT (Case)

OUTPUT
 GND
 INPUT (Case)

OUTPUT
 GND
 INPUT (Case)

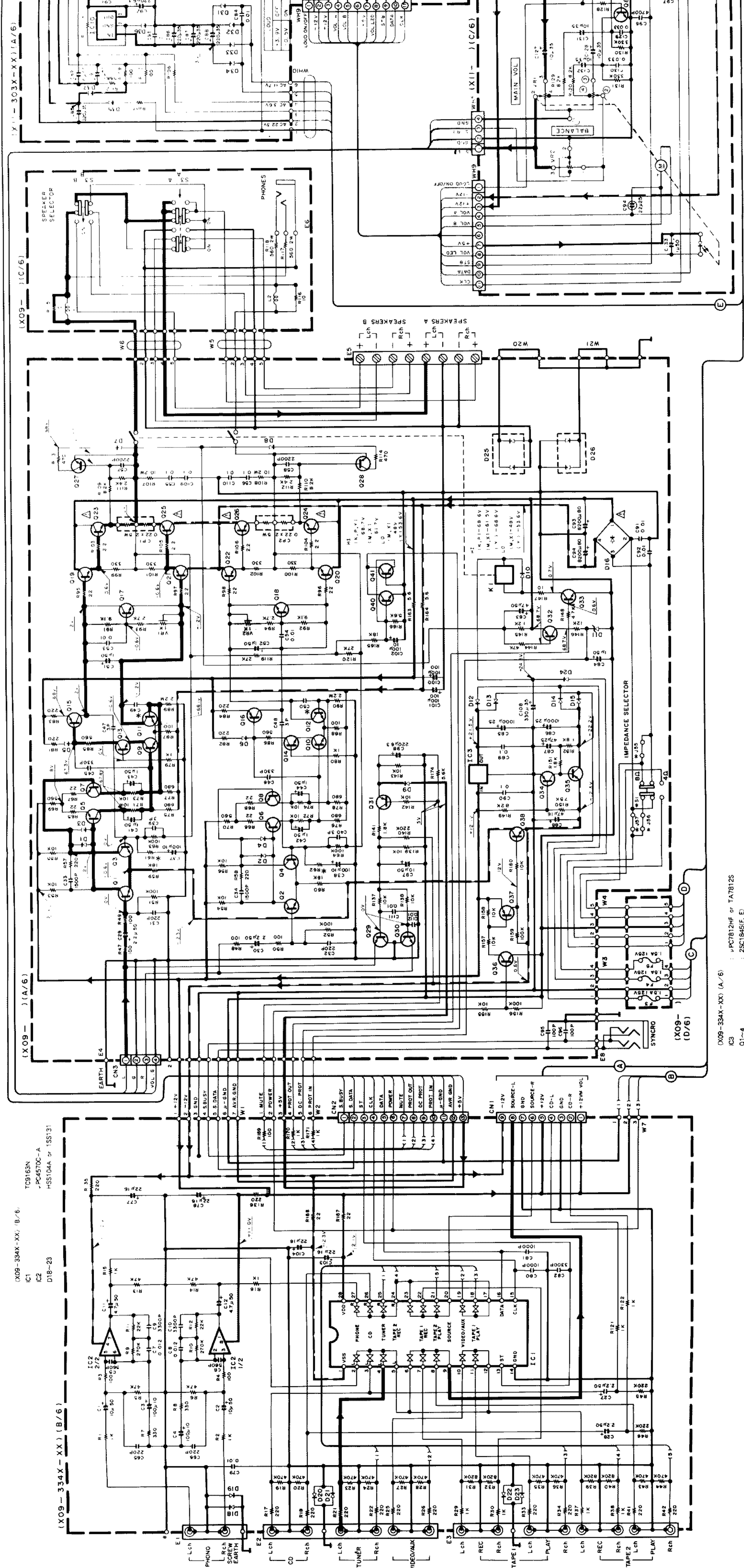

(X09-334X-XX) (B/6)
 IC1 TC9163N
 IC2 PC4570C-A
 HSS104A or 1SS131
 D18-23

(X09-303X-XX) (A/6)

(X09-334X-XX) (A/6)

(X09-334X-XX) (A/6)
 IC3 PC7812HF or TAT812S
 O1-4 2SC1845(F, E)
 O5-8 2SA992(F, E)

2SA1123
 2SA1124
 2SA992
 2SC1845
 2SC2003
 2SC2631
 2SC2632
 2SC2878

2SA1048
 2SA933S
 2SC1740S
 2SC2458

2SA1215
 2SC2921

2SC4137

2SA1535
 2SB941
 2SC3944

2SA1309A
 2SC3311A

TAB409S

BA10393
 UPC4570C-A

UPC7805HF
 UPC7812HF

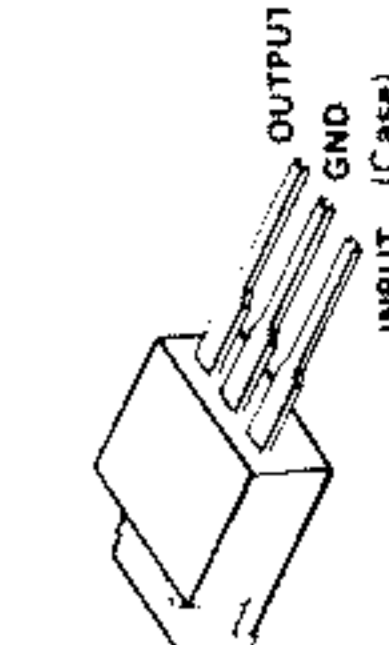
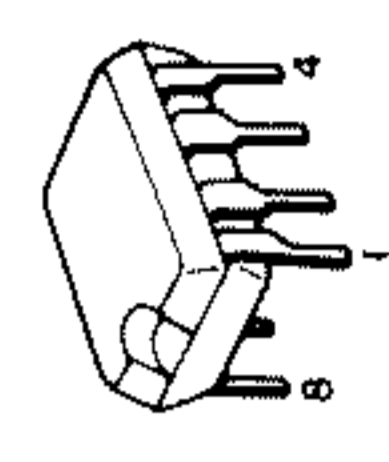
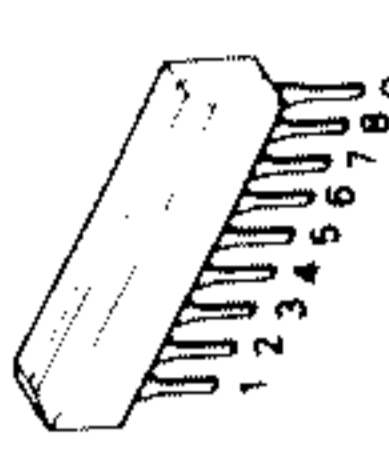
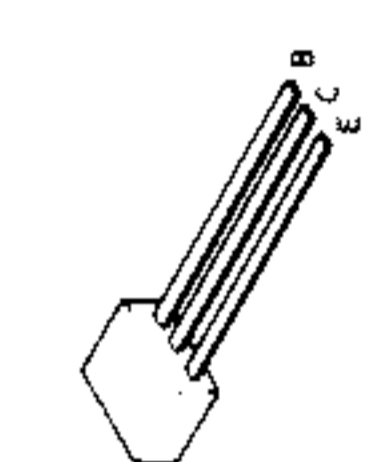
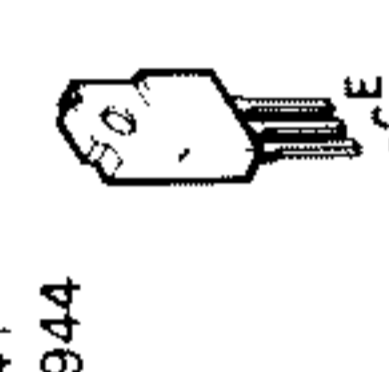
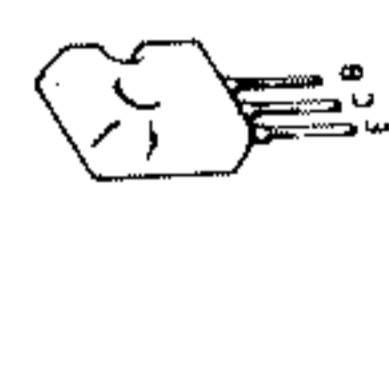
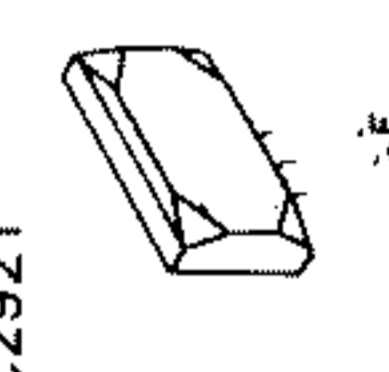
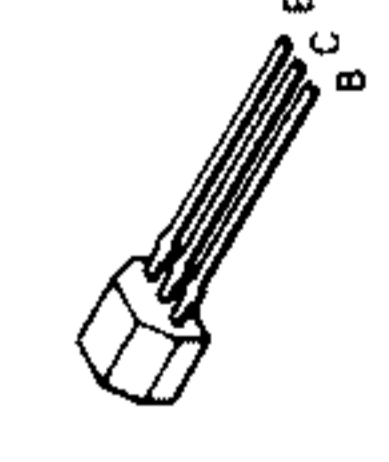
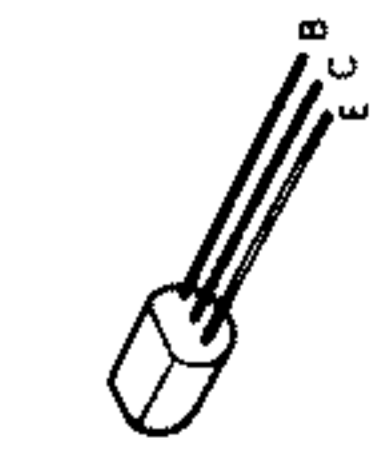

Parts with the exploded numbers larger than 700 are not supplied.

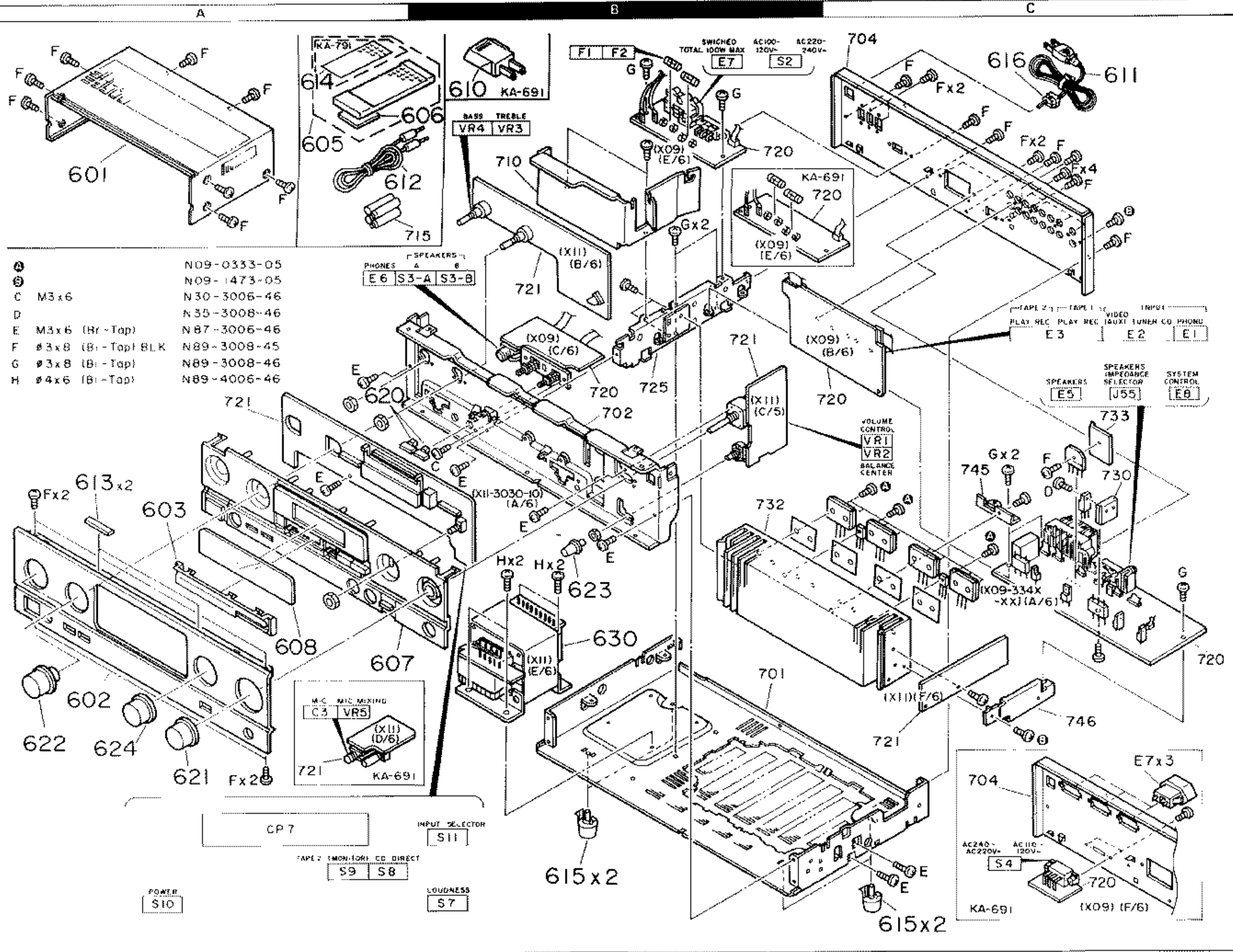

EXPLODED VIEW (MECHANISM)

KA-691/791

KA-691/791

Parts without Parts No. are not supplied.
Les articles sans numéro dans la liste des Parties No. ne sont pas fournis.
Teile ohne Parts No. werden nicht geliefert.

No 1

Ref. No.	Address	Part No.	Description	Desti- nation	Re- marks
参照番号	位置	部品番号	部品名 / 規格	仕	向備考
KA-691 (JAPAN MADE)					
601	1A	A01-1913-01	METALLIC CABINET		
602	2A	A60-0023-02	PANEL	KPYX	
603	2A	A60-0024-02	PANEL	M	
604	2A	A21-1788-03	BRESSING PANEL		
605	1A, 1B	A70-0513-05	REMOTE CONTROLLER ASSY		
606	1A	A09-0112-00	BATTERY COVER		
607	1A, 2A	B01-0481-01	PANEL ESCUTCHEON		
608	2A	B10-1856-03	FRONT GLASS		
-	-	B46-0092-03	WARRANTY CARD	K	
-	-	S46-0094-03	WARRANTY CARD	Y	
-	-	B46-0095-03	WARRANTY CARD	Y	
-	-	B46-0096-23	WARRANTY CARD	X	
-	-	B46-0121-03	WARRANTY CARD	P	
-	-	H58-0513-04	CAUTION CARD (PRESET220-240)	Y	
-	-	B60-0346-00	INSTRUCTION MANUAL (ENGLISH)		
-	-	B60-0534-00	INSTRUCTION MANUAL (FRENCH)		
-	-	B60-0535-00	INSTRUCTION MANUAL (SP, AR, CH)	M	
610	1B	E03-0115-05	AC PLUG ADAPTER	M	
611	1C	E30-0459-05	AC POWER CORD	M	
611	1C	E30-0812-05	AC POWER CORD	Y	
611	1C	E30-0974-05	AC POWER CORD	KP	
611	1C	E30-1341-05	AC POWER CORD	X	
612	1A	E03-1392-05	CORD WITH PLUG		
E7	1B	E03-0055-05	AC OUTLET	M	
E7	1B	E03-0114-05	AC OUTLET	X	
615	2A	G11-0155-14	SMPT TAPE (40X9X2)		
-	-	H00-0352-04	ITEM CARTON CASE		
-	-	H10-0093-02	POLYSTYRENE FOAMED FIXTURE		
-	-	H10-5394-02	POLYSTYRENE FOAMED FIXTURE		
-	-	H25-0223-04	PROTECTION BAG (750X350X0.03)		
-	-	H25-0232-04	PROTECTION BAG (235X350X0.03)		
616	2B, 2C	J02-1313-05	POST		
616	1C	J42-0083-05	POWER CORD BUSHING		
-	-	J61-0307-05	WIRE BAND		
620	1A, 1B	K27-2314-04	KNOB SPEAKERS		
621	2A	K29-4104-04	KNOB VOLUME		
622	2A	K29-4196-04	KNOB BASS, TREBLE		
623	2B	K29-3911-04	KNOB BALANCE		
624	2A	K29-4105-04	KNOB INPUT SELECTOR		
630	2B	L07-0054-05	POWER TRANSFORMER	K	
630	2B	L07-0055-05	POWER TRANSFORMER	Y	
630	2B	L07-0056-05	POWER TRANSFORMER	P	
630	2B	L07-0057-05	POWER TRANSFORMER	M	
640	2H	L07-0058-05	POWER TRANSFORMER	X	
B	1C	N89-3008-41	TAPPING SCREW (M3X8)		
C	1B	N30-3006-46	PAN HEAD MACHIN SCREW		
E	1A, 2B	N87-3006-46	BRAZIER HEAD TAPTITE SCREW		
F	1A, 1B	N89-3008-45	BINDING HEAD TAPTITE SCREW		
G	1B, 2C	N89-3008-46	BINDING HEAD TAPTITE SCREW		
H	2B	N89-4006-46	BINDING HEAD TAPTITE SCREW		

E Scandinavia & Europe K USA P Canada
Y PX (Far East, Hawaii) 1 England M Other Areas
Y AAFES (Europe) X Australia

▲ indicates safety critical components.

Destination list

	JAPAN MADE	SINGAPORE MADE	MALAYSIA MADE
KA-691	K, P, Y, M, X	K	K
KA-791	K, P, Y	K	K

Audio unit

X09-3340-10	KA-691K(J), P, KA-791K(J), P
X09-3340-11	KA-691K(S,M), KA-791K(S,M)
X09-3340-21	KA-691M
X09-3340-71	KA-691X
X09-3342-91	KA-691Y, KA-791(Y)

(J): JAPAN MADE, (S): SINGAPORE MADE, (M): MALYSIA MADE

Control unit

X11-3030-10	KA-691K(J), P, Y, X, KA-791K(J), P, Y
X11-3030-11	KA-691R(S, M), KA-791K(S, M)
X11-3030-21	KA-691M

PARTS LIST

Parts without Parts No. are not supplied. Les articles non mentionnés dans le Parts No. ne sont pas fournis. Teile ohne Parts No. werden nicht geliefert.

No 2

Table with columns: Ref. No., Address, New Parts, Parts No., Description, Destination, Remarks. Includes sub-sections for KA-691 (SINGAPORE MADE), KA-691 (MALAYSIA MADE), and KA-791 (MALAYSIA MADE).

E. Scandinavia & Europe K. USA P. Canada Y. PX (Far East, Hawaii) T. England M. Other Areas Y. AAFES (Europe) X. Australia indicates safety critical components.

Parts without Parts No. are not supplied. Les articles non mentionnés dans le Parts No. ne sont pas fournis. Teile ohne Parts No. werden nicht geliefert.

No 3

Table with columns: Ref. No., Address, New Parts, Parts No., Description, Destination, Remarks. Includes sub-sections for KA-691 (SINGAPORE MADE), KA-791 (JAPAN MADE), and KA-691 (MALAYSIA MADE).

E. Scandinavia & Europe K. USA P. Canada Y. PX (Far East, Hawaii) T. England M. Other Areas Y. AAFES (Europe) X. Australia indicates safety critical components.

PARTS LIST

KA-691/791

KA-691/791

PARTS LIST

Parts without Parts No. are not supplied. Les articles non mentionnés dans le Parts No. ne sont pas fournis. Teile ohne Parts No. werden nicht geliefert.

No 4

Table with columns: Ref. No., Address, New Parts, Parts No., Description, Destination, Remarks. Includes sub-sections for KA-791 (SINGAPORE MADE), KA-791 (MALAYSIA MADE), and KA-791 (MALAYSIA MADE).

E. Scandinavia & Europe K. USA P. Canada Y. PX (Far East, Hawaii) T. England M. Other Areas Y. AAFES (Europe) X. Australia indicates safety critical components.

Parts without Parts No. are not supplied. Les articles non mentionnés dans le Parts No. ne sont pas fournis. Teile ohne Parts No. werden nicht geliefert.

No 5

Table with columns: Ref. No., Address, New Parts, Parts No., Description, Destination, Remarks. Includes sub-sections for KA-791 (SINGAPORE MADE), KA-791 (MALAYSIA MADE), and AUDIO UNIT (X09-334X-XX).

E. Scandinavia & Europe K. USA P. Canada Y. PX (Far East, Hawaii) T. England M. Other Areas Y. AAFES (Europe) X. Australia J. Japan made S. Singapore made (Malaysia made) indicates safety critical components.

PARTS LIST

KA-691/791

SPECIFICATIONS

Rated Power Output

120 watts per channel minimum RMS, both channels driven, at 8 Ω from 20 Hz to 20,000 Hz with no more than 0.03% total harmonic distortion. (FTC)

Total Harmonic Distortion LINE input to SPEAKER output

0.03% at rated power into 8 Ω
10 Hz to 50 kHz, +0 dB, -3 dB

Input Sensitivity/Impedance

2.5 mV/47 kΩ
200 mV/47 kΩ

Signal-to-noise Ratio (IHF-A)

75 dB for 2.5 mV input
100 dB
80 mV, T.H.D. 0.5% at 1 kHz

Output Level/Impedance

200 mV/3.3 kΩ
RIAA standard curve ±0.5 dB (20 Hz to 20,000 Hz)
±10 dB (at 100 Hz)
±10 dB (at 10 kHz)
+8 dB at 100 Hz (at -30 dB VOLUME Level)

General

Power Consumption 2.8 A (U.S.A. & Canada models)

AC outlets

SWITCHED For U.S.A. and Canada: 3; (Total 100 W, 0.8 A max.)

Dimensions

W: 440 mm (17-5/8")
H: 133 mm (5-1/4")
D: 281 mm (11-1/16")
9.1 kg (20.1 lb)

Weight (Net)

Note: KENWOOD follows a policy of continuous advancements in development. For this reason specifications may be changed without notice

Note:

Component and circuitry are subject to modification to insure best operation under differing local conditions. This manual is based on the U.S.A. (KI) standard, and provides information on regional circuit modification through use of alternate schematic diagrams, and information on regional component variations through use of parts list.

KENWOOD CORPORATION

- Kenwood USA Corporation
Kenwood Electronics Canada Inc
Kenwood Electronics UK Limited
Kenwood Electronics Benelux NV
Kenwood Electronics Deutschland GmbH
Kenwood Linear S.p.A
Kenwood Electronics Australia Pty Ltd
Kenwood & Lee Electronics Ltd

No 7

Table with columns: Ref. No., Description, Parts No., Address, etc. for model No 7.

Indicates safety critical components

Y AAFES (Europe)
Y PK Far East, Hawaii
F Canada
K USA
E Scandinavia & Europe

No 6

Table with columns: Ref. No., Description, Parts No., Address, etc. for model No 6.

Indicates safety critical components
Y AAFES (Europe)
Y PK Far East, Hawaii
F Canada
K USA
E Scandinavia & Europe

Parts without Parts No. are not supplied.
Les articles non mentionnés dans le Parts No. ne sont pas fournis.
Teile ohne Parts No. werden nicht geliefert.

No 8

Table with columns: Ref. No., Address, New Parts, Parts No., Description, Destination, Remarks. Includes various transistor and electronic component listings.

CONTROL UNIT (X11-303X-XX)

E Scandinavia & Europe K USA P Canada J Japan made
Y PX (Far East, Hawaii) I England M Other Areas S Singapore made (Malaysia made)
Y AAFES (Europe) X Australia

⚠ indicates safety critical components

Parts without Parts No. are not supplied.
Les articles non mentionnés dans le Parts No. ne sont pas fournis.
Teile ohne Parts No. werden nicht geliefert.

No 9

Table with columns: Ref. No., Address, New Parts, Parts No., Description, Destination, Remarks. Includes various electronic components like capacitors, resistors, and ICs.

E Scandinavia & Europe K USA P Canada J Japan made
Y PX (Far East, Hawaii) I England M Other Areas S Singapore made (Malaysia made)
Y AAFES (Europe) X Australia

⚠ indicates safety critical components

Parts without Parts No. are not supplied.
Les articles non mentionnés dans le Parts No. ne sont pas fournis.
Teile ohne Parts No. werden nicht geliefert.

No 10

Table with columns: Ref. No., Address, New Parts, Parts No., Description, Destination, Remarks. Includes speed detector function components and various ICs.

E Scandinavia & Europe K USA P Canada J Japan made
Y PX (Far East, Hawaii) I England M Other Areas S Singapore made (Malaysia made)
Y AAFES (Europe) X Australia

⚠ indicates safety critical components